

# PAE Kp/ PAE WA Kp/ GPE Kp

AIR COOLED MULTIFUNCTION UNITS FOR 4-PIPE SYSTEMS FOR  
 OUTDOOR INSTALLATION WITH SCROLL COMPRESSORS AND AXIAL FANS

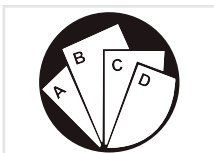

Multiple instructions:  
 Consult the specific part



Read and understand the  
 instructions before underta-  
 king any work on the unit

RETAIN FOR FUTURE REFERENCE

Reproduction, data storage and transmission, even partial, of this publication, in any form, without the prior written authorisation of the Company, is prohibited. The Company can be contacted for all inquiries regarding the use of its products.

The Company follows a policy of continuous product development and improvement and reserves the right to modify specifications, equipment and instructions regarding use and maintenance at any time, without notice.

## **Declaration of conformity**

We declare under our own responsibility that the below equipment complies in all parts with the CEE and EN directives.  
The declaration of conformity is enclosed to the documentation with the unit.

**INDEX**

1. INTRODUCTION .....	5
1.1 Preliminary information .....	5
1.2 Aim and content of the manual .....	5
1.3 How to store this manual .....	5
1.4 Manual updates .....	5
1.5 How to use this manual .....	5
1.6 Potential risks .....	6
1.7 General description of symbols used.....	7
1.8 Safety symbols used.....	8
1.9 Glossary.....	8
1.10 Limitations and prohibited use .....	8
1.11 Unit identification .....	9
2. SAFETY .....	10
2.1 Warning re potentially hazardous toxic substances .....	10
2.2 Refrigerant handling .....	12
2.3 Prevention inhalation of high vapor concentrations.....	12
2.4 Procedures to be adopted in the event of accidental release of refrigerant .....	12
2.5 Main Toxicological Information Regarding the Type of refrigerant used .....	12
2.6 First aid measures .....	12
3. TECHNICAL CHARACTERISTICS .....	13
3.1 Unit description .....	13
3.2 Other versions .....	14
3.3 Options .....	15
3.4 Technical data .....	17
3.5 Operation limits.....	23
3.6 Correction tables.....	25
3.7 Sound data .....	25
4. INSTALLATION .....	26
4.1 General safety guidelines and use of symbols .....	26
4.2 Health and safety Considerations .....	26
4.3 Personal protective equipment .....	26
4.4 Inspection .....	27
4.5 Transport and handling.....	27
4.6 Storage .....	28
4.7 Unpacking.....	28
4.8 Lifting and handling.....	29
4.9 Location and minimum technical clearances .....	30
4.10 Threaded Connection .....	34
4.11 Hydraulic connections.....	34
4.11 Hydraulic circuit.....	36
4.12 Chemical characteristics of the water .....	37
4.13 User circuit minimum water content.....	38
4.14 Filling the hydraulic circuit.....	39
4.15 Emptying the installation.....	39
4.16 Wiring connections: Preliminary safety information .....	40
4.17 Connection of mains cables between multiple units .....	42
4.18 Electric data .....	46
5. UNIT START UP.....	47
5.1 Preliminary Checks.....	47
5.2 Operation of the refrigerant gas detection sensor .....	50
5.3 Safety valves .....	53
5.4 Description of the control panel .....	55
6. USE .....	56
6.1 Quick menu.....	56
6.2 ON / OFF Display .....	56

6.3 Info menu.....	56
6.4 Set point.....	58
6.5 Everest: synoptic of the modular system.....	59
6.6 Access to the main menu.....	60
6.7 Time bands.....	61
6.8 Second Set Point from ID.....	62
6.9 I/O.....	63
6.10 Module control functions.....	65
6.11 Multi-element control functions.....	66
<b>7. MAINTENANCE OF THE UNIT.....</b>	<b>71</b>
7.1 General warnings.....	71
7.2 Drive access.....	72
7.3 Routine maintenance.....	73
7.4 Exceptional Maintenance.....	73
7.5 Periodical checks.....	77
7.6 Refrigerant circuit repair.....	81
<b>8. DECOMMISSIONING.....</b>	<b>82</b>
8.1 Disconnect the unit.....	82
8.2 Disposal, recovery and recycling.....	82
8.3 RAEE directive (only for EC countries).....	82
<b>9. DIAGNOSIS AND TROUBLESHOOTING.....</b>	<b>83</b>
9.1 Fault finding.....	83
<b>10. DIMENSIONAL DRAWING.....</b>	<b>85</b>
<b>EVEREST CONNECTIVITY.....</b>	<b>87</b>
<b>11. INTRODUCTION.....</b>	<b>89</b>
11.1 KG5/KG10 kit installation.....	89
11.2 KGR5/KGR10 and KGH5/KGH10 kit installation.....	90
11.3 KTA kit installation.....	91
<b>12. ACTIVATION AND USE.....</b>	<b>92</b>
12.1 Local Wi-Fi.....	92
12.2 Connections with the KTA kit.....	92
APPENDIX A - PAE Kp Instructions Kit KCA.....	93
APPENDIX B - PAE Kp Instructions Kit KTT.....	94
APPENDIX C - GPE Kp Instructions Kit KCA.....	95
APPENDIX D - GPE Kp Instructions Kit KTT.....	96

## 1. INTRODUCTION

### 1.1 Preliminary information

Reproduction, storage or transmission of any part of this publication in any form, without the prior written consent of the Company, is prohibited.

The unit to which these instructions refer, is designed to be used for the the purposes described and to be operated in accordance with these instructions.

The Company will not be liable for claims for damage caused to persons, animals, material goods or property caused by improper installation, adjustment and maintenance or improper use. Any use not specified in this manual is prohibited.

This document is intended to provide information only and does not form a contract with third parties.

The Company pursues a policy of constant improvement and development of its products and therefore reserves the right to change the specifications and the documentation at any time, without notice and without obligation to update existing equipment.

### 1.2 Aim and content of the manual

These instructions are intended to provide the information required for the selection, installation, use and maintenance of the unit.

They have been prepared in accordance with the European Union laws and with the technical standards in force at the date of issue of the instructions.

The instructions contain all the necessary information to prevent any reasonably foreseeable misuse.

### 1.3 How to store this manual

The manual must be kept in a suitable place with easy access for users and operators, protected from dust and damp.

The manual must always accompany the unit during the entire life cycle of the same and therefore must be transferred to any subsequent user.

### 1.4 Manual Update

It is recommended that the manual is updated to the latest revision available.

If updates are sent to the customer they must be added to this manual.

The latest information regarding the use of its products is available by contacting the Company.

### 1.5 How to use this manual



The manual is an integral part of the unit.



Users or operators must consult the manual before performing any operation and especially so when transporting, handling, installing, maintaining, or dismantling the unit in order to eliminate uncertainty and reduce risk.

In these instructions symbols have been used (described in the following paragraphs) to draw the attention of operators and users to the operations that have a higher risk and which must be performed safely.

## 1.6 Potential Risks

Whilst the unit has been designed to minimize any risk posed to the safety of people who will interact with it, it has not been technically possible to eliminate completely the causes of risk. It is therefore necessary to refer to the requirements and symbolism below:

LOCATION OF RISK	POTENTIAL RISK	METHOD OF INJURY	PRECAUTIONS
Thermal heat exchangers.	Small stab wounds.	Contact	Avoid any contact, use protective gloves.
Fan and fan grilles.	Cuts, eye damage, broken bones.	Insertion of sharp objects through the grid while the fans are operating.	Never put objects through the protection grilles.
Internal component: compressors and discharge pipes	Burns.	Contact	Avoid any contact, use protective gloves.
Internal component: electric cables and metallic parts	Electrocution, severe burns.	Defect in the supply cable insulation, live metallic parts.	Adequate protection of power cables, ensure correct earthing of all metal parts.
External to unit: unit enclosure	Poisoning, severe burns.	Fire due to short circuit or overheating of the supply cable external to unit.	Size cables and mains protection system in accordance with IEE regulations.
Low pressure safety valve. (if present)	Poisoning, severe burns.	High evaporating pressure causing a refrigerant discharge during maintenance.	Carefully check the evaporating pressure during the maintenance operations.
High pressure safety valve. (if present)	Poisoning, severe burns, hearing loss.	Activation of the high pressure safety valve.	If possible, do not open the refrigerant circuit valve; carefully check the condensing pressure; use all the personal protective equipment required by law.
Entire unit	External fire	Fire due to natural disasters or combustions of elements nearby unit	Provide the necessary fire-fighting equipment
Entire unit	Explosion, injuries, burns, poisoning, electrocution for natural disasters or earthquake.	Breakages, failures due to natural disasters or earthquake	Plan the necessary precautions both electrical (suitable differential magneto and electrical protection of the supply lines; greatest care during the connections of the metal parts), and mechanical (special anchors or seismic vibrations to prevent breakages or accidental falls).

## 1.7 General Description of Symbols Used

Safety symbols combined in accordance with ISO 3864-2:



### **BANNED**

A black symbol inside a red circle with a red diagonal indicates an action that should not be performed.



### **WARNING**

A black graphic symbol added to a yellow triangle with black edges indicates danger.



### **ACTION REQUIRED**

A white symbol inserted in a blue circle indicates an action that must be done to avoid a risk.

Safety symbols combined in accordance with ISO 3864-2:



The graphic symbol "warning" is qualified with additional safety information (text or other symbols).

## 1.8 Safety symbols used



### GENERAL RISK

Observe all signs placed next to the pictogram. The failure to follow directions may create a risk situation that may be injurious to the user.



### ELECTRICAL HAZARD

Observe all signs placed next to the pictogram. The symbol indicates components of the unit and actions described in this manual that could create an electrical hazard.



### MOVING PARTS

The symbol indicates those moving parts of the unit that could create risk.



### HOT SURFACES

The symbol indicates those components with high surface temperature that could create risks.



### SHARP SURFACES

The symbol indicates components or parts that could cause stab wounds.



### EARTH CONNECTION

The symbol identifies Earthing connection points in the unit.



### READ AND UNDERSTAND THE INSTRUCTIONS

Read and understand the instructions of the machine before any operations.



### RECOVER OR RECYCLE MATERIAL

## 1.9 Glossary

Within this manual it is indicated with:

Machine/Unit: a single module

Modular system: a group of 2 or more modules (up to 10) operating on a single hydronic circuit.

Warnings, prohibitions or instructions contained in the manual and referring to the unit are also extended to modular systems or vice-versa.

## 1.10 Limitations and prohibited use

The machine is designed and built exclusively for the uses described in "Limitations of use" of the technical manual.

Any other use is prohibited because it may pose a potential risk to the health of operators and users.





The unit is not suitable for operations in environments:

- excessively dusty or potentially explosive atmospheres;
- where there are vibrations;
- where there are electromagnetic fields;
- where there are aggressive atmospheres



### 1.11 Unit identification

Each unit has a rating plate that provides key information regarding the machine. The rating plate may differ from the one shown below as the example is for a standard unit without accessories. For all electrical information not provided on the label, refer to the wiring diagram. A facsimile of the label is shown below:

 <b>EMICON</b> INNOVATION AS ENERGY TEL.+39 0543495611 FAX+39 0543 495612 Via A.Volta 49 Meldola FC ITALY		 NB 0948							
MODELLO MODEL MODELE MODEL	<b>GPE 881 KP</b>	ANNO DI COSTRUZIONE / PED CATEGORIA MANUFACTURE YEAR / PED CATEGORY JAHR VON KONSTRUKT / PED KATEGORIE ANNE DE FABRICAT / CAT&GORIE PED	<b>2023</b> <b>CAT II</b>						
MATRICOLA SERIAL NR N° DE S&RIE STAMM NR	<input type="text"/>	CORRENTE MAX. MAX CURRENT INPUT MAXIMALEN STROM AMP&RES MAXIMALE	<b>A</b>						
ALIMENTAZIONE ELET. SUPPLY VOLTAGE ALIMENTATION ELECT. SPANNUNG	<b>400V+10%-50Hz+2%-3PH-GND</b>	ASSORBIMENTO ELETTRICO NOMINALE PUISSANCE ELECTRIQUE NOMINALE NOMINAL ABSORBED POWER NOMINALELEISTUNGS&UFNAHME	<b>kW</b>						
GAS REFRIGERANTE REFRIGERANT R&FRIGERANT KALTEMITTEL	<b>R290 / 3,3</b>	CORRENTE CORTO CIRCUITO SHORT CIRCUIT CURRENT COURANT COURT-CIRCUIT STROM KURZSCHLUSS	<b>kA 10</b>						
CARICA REFRIGERANTE REFRIGERANT CHARGE KALTEMITTEL CHARGE FRIGORIG&NE	<table border="1" style="width: 100%;"> <tr> <td style="width: 25%;">C1</td> <td style="width: 25%;">C2</td> <td style="width: 25%; text-align: center;">kg.</td> </tr> <tr> <td></td> <td style="text-align: center;">--</td> <td></td> </tr> </table>	C1	C2	kg.		--		PESO OPERATIVO OPERATING WEIGHT POIDS OPERATION. ARBEITSGEWICHT	<b>kg.</b> 
C1	C2	kg.							
	--								
<table border="1" style="width: 100%;"> <tr> <td style="width: 25%;">C1</td> <td style="width: 25%;">C2</td> <td style="width: 25%; text-align: center;">CO2 Ton</td> </tr> <tr> <td></td> <td style="text-align: center;">--</td> <td></td> </tr> </table>	C1	C2	CO2 Ton		--				
C1	C2	CO2 Ton							
	--								
<b>LATO BASSA PRESSIONE / LOW PRESSURE SIDE</b> <b>CIRCUIT BASSE PRESSION / NIEDERDRUCKSEITE</b>		<b>LATO ALTA PRESSIONE / HIGH PRESSURE SIDE</b> <b>CIRCUIT HAUTE PRESSION / HOCHDRUCKSEITE</b>							
PRESSIONE DI PROGETTO DESING PRESSURE PRESSION DE PROJET DRUCK DES PROJEKTES	<input type="text"/> <b>Bar</b>	PRESSIONE DI PROGETTO PS DESING PRESSURE PS PRESSION DE PROJET PS DRUCK DES PROJEKTES PS	<input type="text"/> <b>Bar</b>						
TEMP. MIN PROGETTO MINI DESING TEMPERATURE KLEINSTE TEMP. DES PRDJEKTES TEMP. MOINORE DE PROJET	<b>- 30</b> °C	TEMP. MIN PROGETTO MINI DESING TEMPERATURE KLEINSTE TEMP. DES PRDJEKTES TEMP. MOINORE DE PROJET	<b>- 10</b> °C						
MAX TEMPERATURA PROGETTO MAX DESING TEMPERATURE MAXIMALE TEMP. DES PRDJEKTES MAXIMUM TEMP DE PROJET	<b>+ 54</b> °C	MAX TEMPERATURA PROGETTO MAX DESING TEMPERATURE MAXIMALE TEMP. DES PRDJEKTES MAXIMUM TEMP DE PROJET	<b>+120 GAS</b> <b>+ 65 LIQU</b> °C						
TARATURA ORGANO SICUREZZA SETTING OF SAFETY DEVISE MISE AU POINT DISPOSITIF DE SECURITE EINSTELLWERT ICHERHEITSELEMENT			<input type="text"/> <b>Bar</b>						



The product label should never be removed from the unit.

## 2. SAFETY

### 2.1 Warning on potentially dangerous toxic substances

#### 2.1.1 Identification of the used fluid: R290 (Propane)

**WARNING!**

**The refrigerant R290 (PROPANE) is flammable and it must be handled only by competent and responsible operators, under the conditions specified in the safety regulations in force.**



DO NOT SMOKE

NO NAKED FLAMES





The refrigerant used is Propane (R290). In compliance with 2014/68/EU directive (hereafter: PED), this substance is considered a gas (PED, art. 13) of Group 1 which contains the dangerous fluids (extremely flammable). According EN 378-1, att. F, Propane is classified as a Group 3 substance (low toxicity, high flammability).

Safety information of this refrigerant are listed in the following table

Chemical name	Propane
Designation (ISO 817)	R290
Chemical formula	$C_3H_8$
Safety group (EN378-1)	A3
PED classification	Group 1 Gas
Lower flammability limit (LFL)	0,038 kg/m <sup>3</sup> – 2,1% m <sup>3</sup> /m <sup>3</sup>
Upper flammability limit (UFL)	0,177 kg/m <sup>3</sup> – 9,8% m <sup>3</sup> /m <sup>3</sup>
Vapour density (at 25°C, 101.3 kPa)	1,832 kg/m <sup>3</sup>
Relative density	1,56
Molecular mass	44 kg/kmol
Normal boiling point	-42°C
Self-ignition temperature	470°C
Flammability temperature	-104°C
Ozone Depletion Potential (ODP)	0
Global Warming Potential (GWP - 100-year time horizon)	3 (CO <sub>2</sub> = 1)

Note that Propane has an higher density than air one, therefore in case of leaks, it will tend to flow down

CHEMICAL COMPOSITION OF PROPAN USED AS A REFRIGERANT:

Refrigerant content  $\geq 99,5\%$  by mass

Organic impurities  $\leq 0,5\%$  by mass

1,3 Butadiene (for each single unsaturated multiple hydrocarbon)	$\leq 5$ ppm in mass
Normal Hexane	$\leq 50$ ppm in mass
Benzene (for each aromatic mixture)	$\leq 1$ ppm in mass
Sulfur	$\leq 2$ ppm in mass
Non-condensable gases	$\leq 1,5\%$ by volume of vapour phase
Water	$\leq 25$ ppm in mass
Acid content	$\leq 0,02$ mg KOH/g for neutralisation
Evaporation residue	$\leq 50$ ppm in mass
Particles / solids	None (visual inspection)
Evaporating temperature glide	$\leq 0,5$ K
Practical limit (EN378-1, all.F)	$0,008$ kg/m <sup>3</sup>
Acute Toxicity Exposure Limit (ATEL) / O2 Deprivation Limit	$0,09$ kg/m <sup>3</sup>

Propane highlights compatibility problems with some rubber or plastic types, particularly if chlorinated. Tests on critical materials will be required.

### 2.1.2 Identification of the Type of Oil Used.

The lubricant used is polyester oil. Please refer to the information provided on the compressor data plate.

Main Ecological Information Regarding the Types of refrigerants Fluids used.



**ENVIRONMENTAL PROTECTION** : Read the ecological information and the following instructions carefully.

### 2.1.3 Effects of discharges

Discharges into the atmosphere of this product does not cause a long-term contamination.

### 2.1.4 Exposure controls and personal protection

Wear protective clothing and gloves, protect your eyes and face

### 2.1.5 Professional exposure limits

Limit values TLV-TWA: 2500 ppm

## 2.2 Refrigerant handling



Users and maintenance personnel must be adequately informed about the possible risks of handling potentially toxic substances. Failure to follow such instructions can cause damage to personnel or to the unit.

## 2.3 Prevent inhalation of high vapor concentration

Atmospheric concentrations of refrigerant must be minimized and kept to a level that is below the occupational exposure limit. Vapor is heavier than air and can form dangerous concentrations near the ground where the ventilation rate is lower. Always ensure adequate ventilation. Avoid contact with open flames and hot surfaces as this can cause toxic and irritating decomposition products to form. Avoid contact between liquid refrigerant and the eyes or skin.

## 2.4 Procedures to be adopted in the event of accidental release of refrigerant

Ensure suitable personal protection (especially respiratory protection) during cleaning operations. If deemed safe, isolate the source of the leak. If the leakage is small and if adequate ventilation is provided, allow the refrigerant to evaporate. If the loss is substantial ensure that measures are taken to adequately ventilate the area. Contain spilled material with sand, earth or other suitable absorbent material. Do not allow the refrigerant to enter drains, sewers or basements, as pockets of vapor can form.

## 2.5 Main Toxicological Information Regarding the Type of refrigerant used

### 2.5.1 Inhalation

A high atmospheric concentration can cause anaesthetic effects with possible loss of consciousness. Prolonged exposure may lead to irregular heartbeat and cause sudden death. Higher concentrations may cause asphyxia due to the reduced oxygen content in the atmosphere.

### 2.5.2 Contact with skin

Splashes of nebulous liquid can produce frostbite. Probably not hazardous if absorbed through the skin. Repeated or prolonged contact may remove the skin's natural oils, with consequent dryness, cracking and dermatitis.

### 2.5.3 Contact with eyes

Splashes of liquid may cause frostbite.

### 2.5.4 Ingestion

While highly improbable, may produce frostbite.

## 2.6 First Aid Measures



Adhere scrupulously to the warnings and first aid procedures indicated in the REFRIGERANT AND LUBRICANT OIL SAFETY DATA SHEET downloadable via the following QR codes.



Always referred to the compressor nameplate to identify the type of oil used in the refrigeration circuit.



**REFRIGERANT:** R290 Safety data sheet – IT  
**OIL:** Everest290 – Oil ZEROL RFL 68EP – EN

### 3. TECHNICAL CHARACTERISTICS

#### 3.1 Unit description

Air/water heat pump for modular installation, EMICON EVEREST290 – PAE Kp series, monobloc unit for outdoor installation, particularly suitable for residential, commercial and industrial applications where the production of hot water at high temperature is required, at the highest efficiency values on the market. Also available is the multipurpose version with 4 pipes series EMICON EVEREST290 – GPE Kp required if there is a need to produce hot water and chilled water simultaneously.

The refrigerant used is Propane, a non-toxic hydrocarbon, even at high concentrations, with almost a null ozone depletion potential, negligible global warming potential and thermodynamic properties which allow to reach high efficiency values.

All the units are totally factory assembled and tested, following specific quality procedures. Besides they are totally hydraulic, cooling and electrical connected permitting a quick installation once on site. Before the test the cooling circuits of each unit are subjected to a pressure test and then charged with Refrigerant R290 and non-freezing oil. Units are designed for outdoor installation in areas not accessible to unauthorised persons, in compliance with the European standard EN 378 and his updates.

Units CE certified in compliance with the European regulation 813/2013 (low-temperature heat pumps/average climate conditions).

##### 3.1.1 Frame

The structure, strong and compact, is made of a base and frame in high-thickness galvanized steel elements assembled with stainless steel rivets. All galvanized steel parts placed externally are protected on the surface level with an oven powder coating system in RAL 7035 colour. The basement is designed in order to allow the unit to be forked and handled by standard lifting devices. The refrigerant circuit (except for the source side exchanger) is sealed from the rest of the unit. Internally, it also contains a refrigerant leakage sensor. In case of severe sensor alarm, the power supplied to all equipment is interrupted, except for the emergency fans, which activate in order to remove the potentially explosive atmosphere from the cabinet. The units are equipped as standard with a condensate drip tray with a thermoregulated antifreeze heater with discharge at the base

##### 3.1.2 Compressors

The compressors, specially designed to operate with R290, are Scroll type with orbiting spirals, optimized for heat pump operating mode and high compression ratios. They are installed in tandem configuration, mounted on rubber dampers, and equipped with direct-start engines cooled by the suctioned refrigerant gas. They are also fitted with built-in thermistor protection with manual reset, which safeguards them from overloads. The crankcase oil sump, PAG type, is equipped with a heating resistor. The compressors terminal block has an IP54 protection rating. Activation and deactivation of the compressors are controlled by the on-board microprocessor, which regulates the thermo-cooling power delivered. The microprocessor has inside the compressor starting counter function, which allows the reading of the total number of compressor starts.

##### 3.1.3 Heat exchanger

The heat exchanger is stainless steel "single-circuit" plate type, thermally insulated by a flexible closed-cell insulating mat of high thickness and UV-resistant. The evaporator is also equipped with a safety flow switch on the water flow side that does not allow the unit to operate if there is a lack of water in the heat exchanger.

##### 3.1.4 Coils

The coils are made with micro-finned copper pipes arranged in staggered rows and mechanically expanded inside an aluminium-finned pack with hydrophilic treatment. The fin shape ensures maximum heat exchange efficiency. The innovative mini-channel technology, besides guaranteeing maximum performance in terms of heat exchange, allows the refrigerant charge to be at the minimum necessary values for the correct operation of the unit. The maximum operating pressure on the refrigerant side of the heat exchange coils corresponds to 31 bar (relative).

##### 3.1.5 Axial Fans

Axial fans, with external rotor directly coupled to a three-phase electronically commutated motor (EC) they have the possibility of a continuous regulation of the speed by means of a 0-10V signal completely managed by the microprocessor. Aluminum blades with wings profile are suitably designed to avoid any turbulence in the air detachment zone, granting in this way the max efficiency with the minimum noise level. The fan is equipped with galvanized steel protection grid painted after the construction. Thanks to a more accurate adjustment of air flow, they allow operation of the unit with external temperature down to -20 °C.

##### 3.1.6 Cooling circuit

The cooling circuit includes a 4-way cycle reversing valve, liquid receiver, liquid/gas separator, and electronic thermostatic expansion valves operating in parallel (to allow the unit to work constantly along the entire working range). It also includes a liquid passage and humidity indicator, filter drier, safety valve, high-pressure switches with manual and automatic reset, service valve for the addition of the refrigerant and anti-freeze probe.

### 3.1.7 Hydraulic circuit

The hydraulic circuit consists of a 2-pole centrifugal electric pump that allows water to circulate inside the utility-side exchanger. A check valve that prevents the recirculation of the treated fluid in the case of a pump off and unit combined with others operating on the same water circuit. The water piping inside the unit including the Victaulic joints present are insulated in the factory with heat-insulating material of adequate thickness.

### 3.1.8 Electrical board

The electrical board is designed in accordance with the European standards 61439-1 EN 60204. Its structure is watertight and it contains all the components of the control system, those required for starting the unit, and the thermal protection of the electric motors, connected and factory-tested.

It houses all the power and control components: the microprocessor electronic board, with keyboard and display for the visualization of the various functions, main disconnecting switch for the door lock, and isolation transformer for the auxiliary circuit supply.

It also contains circuit breakers, fuses, and contactors for the compressor and fan motors, the terminals for the cumulative alarms and remote ON/OFF, the terminal board of the spring-type control circuits, and the possibility of connection to BMS management systems.

In case of a lack of ventilation in the compressor compartment, the unit blocks all the electrical drives.

### 3.1.9 Refrigerant gas detection sensor

As standard, the unit is equipped with a sensor located inside the compressor compartment, which continuously analyses the surrounding air and generates an alarm in the system if a refrigerant concentration above the threshold values is detected (due to a leak). The sensor is electrically connected to a control unit located inside the electrical panel, which coordinates its operational functions.

## 3.2 Other versions

### 3.2.1 Standard version

**PAE Kp:** Reversible heat pump fully optimised for cooling operation, able to operate down to outside air temperatures of -20°C and produce hot water up to 70°C.

**PAE WA Kp:** Reversible heat pump fully optimised for cooling operation, able to operate down to outside air temperatures of -20°C and produce hot water up to 65°C with efficiencies such as to meet the efficiency objectives established by Ecobonus and Conto Termico.

**GPE Kp:** Multipurpose 4-pipes unit fully optimised for cooling operation, able to operate down to outside air temperatures of -20°C and produce hot water up to 70°C.

### 3.3 Options

- A+V** **Amperometer and voltmeter:** Electrical devices used to measure the electrical current absorbed and the electrical supply voltage of the unit.
- CFP** **Pump protection crankcase:** Crankcase made of galvanized and painted sheet metal. The crankcase is mounted in correspondence of the present pumps fixing it firmly to the base of the unit.
- CI** **Soundproofing jacket on compressors:** Made of soundproofing material, wrapped all around compressors so to further reduce the overall sound level of the unit.
- ECP** **Anticorrosive electro coating protection of condensing coils:** Treatment of the coils composed by electro deposition process of epoxy paint particle forming an uniform and continuous film over the whole surface of exchanger, creating a flexible and smooth coating that is particularly resistant to corrosive agents. This type of treatment is indicated in case of installation in high contaminants concentration industrial environments ( >100ppm ), high atmospheric pollution urban areas ( >125 ug/m<sup>3</sup> ) or near costal areas.
- HRV2** **High pressure double safety valve.**
- IH** **RS 485 Serial interface:** Electronic card to be connected to the microprocessor to allow connection of the units to supervision systems, for a remote control and monitoring of the unit. (Alternative to IWG).
- IWG** **SNMP or TCP/IP Protocol serial interface:** Electronic card to be connected to the microprocessor to allow the connection of the unit to external supervision system with SNMP or TCP/IP Protocol for a remote control and monitoring of the unit. (Alternative to IH).
- KCA** **Water collector kit without insulation:** Kit consisting of water collectors (6" diameter), ball valves, support brackets, and all the necessary for the hydraulic connection between the unit and the collectors (Supplied in kit).
- KCC** **Water collector insulation kit:** Shells made of 9 mm thermal insulating material of proper for the water collector insulation (KCA) (Supplied in kit).
- KG5** **Gateway framework kit up to 5 units:** Frameworks for communication data with each module of a modular system (up to 5 units). The provision for mounting the panel is on the back of the front cover of each unit. The prearrangement for the panel installation is placed on the front-cover back of each unit. Mandatory kit for systems with two or more modules. The supply does not include cables (power or data transmission) for the connection of the kit to the unit. The KNS (network starter kit) will be supplied in conjunction with the panel, a device that allows the modular system to be restarted after an electrical blackout. (The material is supplied in kits).
- KG10** **Gateway framework kit up to 10 units:** Frameworks for communication data with each module of a modular system (up to 10 units). The provision for mounting the panel is on the back of the front cover of each unit. The prearrangement for the panel installation is placed on the front-cover back of each unit. Mandatory kit for systems with two or more modules. The supply does not include cables (power or data transmission) for the connection of the kit to the unit. The KNS (network starter kit) will be supplied in conjunction with the panel, a device that allows the modular system to be restarted after an electrical blackout. (The material is supplied in kits).
- KGH1** **Gateway kit for single module complete with Hi-Web and Wi-Fi router:** Framework that allows the monitoring and supervision of the main operating parameters by accessing the Hi-Web platform from the local Wi-Fi network. The interface that can be used can be a customer device (smartphone or tablet). The arrangement for mounting the panels is on the back of the front cover of each unit. The supply does not include cables (power or data transmission) for the connection of the kit to the unit (Supplied in kit).
- KGH5** **Gateway kit from 2 to 5 units complete with Hi-Web and Wi-Fi routers:** Frameworks for communication and interfacing data with each module of a modular system (up to 5 units). It allows the monitoring and supervision of the main operating parameters of the single modules and the whole system, by accessing the Hi-Web platform from the local Wi-Fi network. The interface that can be used can be a customer device (smartphone or tablet) or the tablet interface integrated in the unit (optional KTA). The arrangement for mounting the panels is on the back of the front cover of each unit. The supply does not include cables (power or data transmission) for the connection of the kit to the unit (Supplied in kit).
- KGH10** **Gateway kit from 6 to 10 units complete with Hi-Web and Wi-Fi routers:** Frameworks for communication and interfacing data with each module of a modular system (up to 10 units). It allows the monitoring and supervision of the main operating parameters of the single modules and the whole system, by accessing the Hi-Web platform from the local Wi-Fi network. The interface that can be used can be a customer device (smartphone or tablet) or the tablet interface integrated in the unit (optional KTA). The arrangement for mounting the panels is on the back of the front cover of each unit. The supply does not include cables (power or data transmission) for the connection of the kit to the unit (Supplied in kit).



- KGR1 Gateway kit for single module complete with Wi-Fi router:** Framework that allows the monitoring and supervision of the main operating parameters by accessing the local Wi-Fi network. The interface that can be used can be a customer device (smartphone or tablet). The arrangement for mounting the panels is on the back of the front cover of each unit. The supply does not include cables (power or data transmission) for the connection of the kit to the unit (Supplied in kit).
- KGR5 Gateway kit from 2 to 5 units complete with Wi-Fi router:** Frameworks for communication and interfacing data with each module of a modular system (up to 5 units). It allows the monitoring and supervision of the main operating parameters of the single modules, via local Wi-Fi network. The interface that can be used can be a customer device (smartphone or tablet) or the tablet interface integrated in the unit (kit KTA). The arrangement for mounting the panels is on the back of the front cover of each unit. The supply does not include cables (power or data transmission) for the connection of the kit to the unit (Supplied in kit).
- KGR10 Gateway kit from 6 to 5 units complete with Wi-Fi router:** Frameworks for communication and interfacing data with each module of a modular system (up to 10 units). It allows the monitoring and supervision of the main operating parameters of the single modules, via local Wi-Fi network. The interface that can be used can be a customer device (smartphone or tablet) or the tablet interface integrated in the unit (kit KTA). The arrangement for mounting the panels is on the back of the front cover of each unit. The supply does not include cables (power or data transmission) for the connection of the kit to the unit (Supplied in kit).
- KLD Display interface kit for refrigerant leak sensor - calibration free:** Portable interface kit with graphic display that can be connected to the refrigerant leak sensor control board via a 4-pole cable (supplied in the kit). It allows you to carry out the operations of checking and setting the operating parameters of the sensor during periodic inspection and service.
- KP5 Power / executor framework kit up to 5 modules:** Electrical panel with IP54 protection rating consisting of 5 circuit breakers and a main disconnecting switch for switching the main power supply to the individual units of the modular system (up to 5). The supply does not include the cables (power supply or data transmission) for connecting the kit to the unit. (Supplied as a kit)
- KP10 Power / executor framework kit up to 10 modules:** Electrical panel with IP54 protection rating consisting of 10 circuit breakers and a main disconnecting switch for switching the main power supply to the individual units of the modular system (up to 10). The supply does not include the cables (power supply or data transmission) for connecting the kit to the unit. (Supplied as a kit)
- KTA Kit tablet interface:** Integrated inside the front cover of the unit and protected by a sheet metal door with key, it allows access to the Hi-Web and then visualization and complete control of the main operating parameters of the modular system (available in association with KGR5/10 or KGH5/10 and supplied in kit).
- KTT Victaulic cap + socket kit/weld:** Kit consisting of Victaulic caps, Victaulic sockets, and Victaulic couplings (including insulation) necessary for sealing one end of the water collector and for connecting the other end to the user circuit (Supplied in kit).
- MG Lifting hooks:** Side brackets firmly fixed to the basement allow the unit to be lifted with hooks and cables.
- MT Pressure gauges:** These enable the standing charge and the operating pressures to be monitored.
- PA Rubber-type vibration dampers:** Vibration bell type dampers for insulating the unit from the support base (supplied in kit), composed of a bell base in galvanized steel and rubber compound.
- PM Spring-type vibration dampers:** Spring-type vibration dampers support, for insulating the unit (supplied in kit), mainly indicated for installation in difficult and aggressive environments. Made of two steel plates containing a suitable quantity of harmonic steel springs.
- PQ Remote display:** Remote interface displaying temperature values detected by probes, alarm digital inputs, outputs, remote ON/OFF of the unit. It also gives the possibility to change and program parameters and report/display alarms.
- RA Anti-freeze heater on evaporator:** Electrical heater installed on the evaporator, in order to prevent freezing and provided with thermostat.
- RR Copper/Copper coil:** Special condensing coils with copper pipes and fins. (Available for free-cooling version, only).
- VB Brine Version:** Unit suitable for working with evaporator outlet water temperatures lower than 0°C. A 20 mm evaporator insulation will be provided.
- VH Heating cable on internal water pipes:** Electric heaters are wrapped around the water pipes of the unit. They are provided with anti-freeze function and equipped with an autonomous thermostat.



### 3.4 Technical data

<b>EPAE 881 Kp</b>		
<b>Cooling <sup>(1)</sup></b>		
Nominal cooling capacity (EN14511)	kW	66,3
Total input power (EN14511)	kW	26,4
Total nominal current	A	50,8
EER (EN14511)	-	2,51 *
Refrigerant circuits	n°	1
Compressors	n°	2
<b>Axial fans <sup>(1)</sup></b>		
Number	n°	2
Total air flow	m <sup>3</sup> /h	35390
Total fan power input	kW	1,8
Total fan current	A	3,3
<b>User side plate exchanger <sup>(1)</sup></b>		
Number	n°	1
Total capacity	m <sup>3</sup> /h	11,3
Pressure drop	kPa	27,4 *
Diameter of water connections	DN	2" Victaulic *
<b>Pump group P1 <sup>(1)</sup></b>		
Total electrical power input	kW	0,73
Current	A	1,4
Total electrical power input (unit side)	kW	0,2
<b>Heating <sup>(2)</sup></b>		
Heating capacity (EN14511)	kW	88,9
Total input power (EN14511)	kW	22,2
Total nominal current	A	45,9
SCOP <sup>(3)</sup>	-	3,87 *
COP (EN14511)	-	4,00 *
<b>Axial fans <sup>(2)</sup></b>		
Total air flow	m <sup>3</sup> /h	32480
Total fan power input	kW	1,6
Total fan current	A	3,0
<b>User side plate exchanger <sup>(2)</sup></b>		
Total capacity	m <sup>3</sup> /h	15,4
Pressure drop	kPa	43,6 *
Diameter of water connections	DN	2" Victaulic *
<b>Pump group P1 <sup>(2)</sup></b>		
Total electrical power input	kW	0,8
Current	A	1,6
Total electrical power input (unit side)	kW	0,3

Everest PAE 881 Kp		
<b>Refrigerant data R290</b>		
Refrigerant charge	Kg	6,1
Global warming potential (GWP)	-	0,02
Equivalent CO <sub>2</sub> charge	Kg	0,12
<b>Weights</b>		
Transport weight	Kg	835
Operating weight	Kg	840
<b>Dimensions</b>		
Length	mm	2560 *
Depth	mm	1100
Height	mm	2450 *
<b>Sound data</b>		
Sound power level <sup>(4)</sup>	db(A)	86,5 **
Sound pressure level <sup>(5)</sup>	db(A)	54,6 **
<b>Power supply</b>		
Voltage/Phase/Frequency	V/Ph/Hz	400/3/50

Performances are referred to the following conditions:

- (1) Fluid: water - in/out temperature: 12/7°C - air 35°C.
- (2) Fluid: water - in/out temperature: 30/35°C - air 7°C - UR.87%
- (3) Average conditions, low temperature, fixed - REG. EU 813/2013.
- (4) Sound power level in accordance with ISO 3744 (In heating mode at conditions specified in point 2).
- (5) Sound pressure level at 10 mt from the unit in free field conditions in accordance with ISO 3744.

\*\* In case of modular system see paragraph "3.7 Sound data".



Technical data are not binding and may change without notice, therefore ALWAYS refer to the data sheet received with the offer.



Technical data relating to the unit. In the case of a modular system with n units, multiply the data (except those marked with \*) by n to obtain the total values.

<b>Everest PAE 881 WA Kp</b>		
<b>Cooling <sup>(1)</sup></b>		
Nominal cooling capacity (EN14511)	kW	105
Total input power (EN14511)	kW	29,6
Total nominal current	A	55,0
EER (EN14511)	-	3,55 *
SEER <sup>(2)</sup>	-	4,58
Refrigerant circuits	n°	1
Compressors	n°	2
<b>Axial fans <sup>(1)</sup></b>		
Number	n°	2
Total air flow	m <sup>3</sup> /h	38770
Total fan power input	kW	2,3
Total fan current	A	4,1
<b>User side plate exchanger <sup>(1)</sup></b>		
Number	n°	1
Total capacity	m <sup>3</sup> /h	18,0
Pressure drop	kPa	55,5 *
Diameter of water connections	DN	2" Victaulic *
<b>Pump group P1 <sup>(1)</sup></b>		
Total electrical power input	kW	0,9
Current	A	1,6
Total electrical power input (unit side)	kW	0,5
<b>Heating <sup>(3)</sup></b>		
Heating capacity (EN14511)	kW	88,2
Total input power (EN14511)	kW	22,5
Total nominal current	A	46,3
SCOP <sup>(4)</sup>	-	3,77 *
COP (EN14511)	-	3,92 *
<b>Axial fans <sup>(3)</sup></b>		
Total air flow	m <sup>3</sup> /h	32470
Total fan power input	kW	1,54
Total fan current	A	3,01
<b>User side plate exchanger <sup>(3)</sup></b>		
Total capacity	m <sup>3</sup> /h	15,3
Pressure drop	kPa	43,5 *
Diameter of water connections	DN	2" Victaulic *
<b>Pump group P1 <sup>(3)</sup></b>		
Total electrical power input	kW	0,8
Current	A	1,6
Total electrical power input (unit side)	kW	0,3

Everest PAE 881 WA Kp		
<b>Refrigerant data R290</b>		
Refrigerant charge	Kg	6,1
Global warming potential (GWP)	-	0,02
Equivalent CO <sub>2</sub> charge	Kg	0,12
<b>Weights</b>		
Transport weight	Kg	835
Operating weight	Kg	840
<b>Dimensions</b>		
Length	mm	2560 *
Depth	mm	1100
Height	mm	2450 *
<b>Sound data</b>		
Sound power level <sup>(5)</sup>	db(A)	86,5 **
Sound pressure level <sup>(6)</sup>	db(A)	54,6 **
<b>Power supply</b>		
Voltage/Phase/Frequency	V/Ph/Hz	400/3/50

Performances are referred to the following conditions:

- (1) Fluid: water - in/out temperature: 23/18°C - air 35°C.
- (2) Calculated according to EU 2016/2281 - Cooling floor application (23/18°C)
- (3) Fluid: water - in/out temperature: 30/35°C - air 7°C - UR.87%
- (4) Average conditions, low temperature, fixed - REG. EU 813/2013
- (5) Sound power level in accordance with ISO 3744 (In heating mode at conditions specified in point 3).
- (6) Sound pressure level at 10 mt from the unit in free field conditions in accordance with ISO 3744

\*\* In case of modular system see paragraph "3.7 Sound data".



Technical data are not binding and may change without notice, therefore ALWAYS refer to the data sheet received with the offer.



Technical data relating to the unit. In the case of a modular system with n units, multiply the data (except those marked with \*) by n to obtain the total values.

<b>Everest GPE 881 Kp</b>		
<b>Cooling <sup>(1)</sup></b>		
Nominal cooling capacity (EN14511)	kW	72,1
Total input power (EN14511)	kW	26,6
Total nominal current	A	51,1
EER (EN14511)	-	2,71 *
Refrigerant circuits	n°	1
Compressors	n°	2
<b>Axial fans <sup>(1)</sup></b>		
Number	n°	2
Total air flow	m <sup>3</sup> /h	35070
Total fan power input	kW	1,7
Total fan current	A	3,2
<b>Cold user side plate exchanger <sup>(1)</sup></b>		
Number	n°	1
Total capacity	m <sup>3</sup> /h	12,3
Pressure drop	kPa	32,4 *
Diameter of water connections	DN	2" Victaulic *
<b>Pump group P1F <sup>(1)</sup></b>		
Total electrical power input	kW	0,8
Current	A	1,5
Total electrical power input (unit side)	kW	0,2
<b>Heating <sup>(2)</sup></b>		
Heating capacity (EN14511)	kW	86,7
Total input power (EN14511)	kW	22,2
Total nominal current	A	44,6
COP (EN14511)	-	3,91 *
<b>Axial fans <sup>(2)</sup></b>		
Total air flow	m <sup>3</sup> /h	34120
Total fan power input	kW	1,8
Total fan current	A	3,4
<b>Hot user side plate exchanger <sup>(2)</sup></b>		
Total capacity	m <sup>3</sup> /h	15
Pressure drop	kPa	41,7 *
Diameter of water connections	DN	2" Victaulic *
<b>Pump group P1C <sup>(2)</sup></b>		
Total electrical power input	kW	0,8
Current	A	1,6
Total electrical power input (unit side)	kW	0,3
<b>Cooling while heating <sup>(3)</sup></b>		
Cooling capacity (EN14511)	kW	79,5
Heating capacity (EN14511)	kW	101
Total input power	kW	21,5
Total nominal current	A	45,42
TER (EN14511)	-	8,40 *
<b>Hot user side plate exchanger <sup>(3)</sup></b>		
Inlet temperature	°C	30
Outlet temperature	°C	35,8
Total capacity	m <sup>3</sup> /h	15
Pressure drop	kPa	41,7 *

Everest GPE 881 Kp		
<b>Pump group P1C <sup>(3)</sup></b>		
Total electrical power input	kW	0,8
Current	A	1,6
Total electrical power input (unit side)	kW	0,3
<b>Cold user side plate exchanger <sup>(3)</sup></b>		
Inlet temperature	°C	12
Outlet temperature	°C	6,4
Total capacity	m <sup>3</sup> /h	12,3
Pressure drop	kPa	32,5 *
<b>Pump group P1F <sup>(3)</sup></b>		
Total electrical power input	kW	0,8
Current	A	1,5
Total electrical power input (unit side)	kW	0,2
<b>Refrigerant data R290</b>		
Refrigerant charge	Kg	6,1
Global warming potential (GWP)	-	0,02
Equivalent CO <sub>2</sub> charge	Kg	0,12
<b>Weights</b>		
Transport weight	Kg	920
Operating weight	Kg	935
<b>Dimensions</b>		
Length	mm	2560 *
Depth	mm	1100
Height	mm	2450 *
<b>Sound data</b>		
Sound power level <sup>(4)</sup>	db(A)	86,5 **
Sound pressure level <sup>(5)</sup>	db(A)	54,6 **
<b>Power supply</b>		
Voltage/Phase/Frequency	V/Ph/Hz	400/3/50

Performances are referred to the following conditions:

(1) Fluid: water - in/out temperature: 12/7°C - air 35°C.

(2) Fluid: water - in/out temperature: 30/35°C - air 7°C - UR.87%

(3) Cold outlet user side: in temperature: 7°C - Nominal flow rate cooling- Hot outlet user side: in temperature: 35°C - Nominal flow rate heating.

(4) Sound power level in accordance with ISO 3744 (In heating mode at conditions specified in point 2).

(5) Sound pressure level at 10 mt from the unit in free field conditions in accordance with ISO 3744.

\*\* In case of modular system see paragraph "3.7 Sound data".



Technical data are not binding and may change without notice, therefore ALWAYS refer to the data sheet received with the offer.



Technical data relating to the unit. In the case of a modular system with n units, multiply the data (except those marked with \*) by n to obtain the total values.

### 3.5 Operational limits

#### 3.5.1 PAE Kp

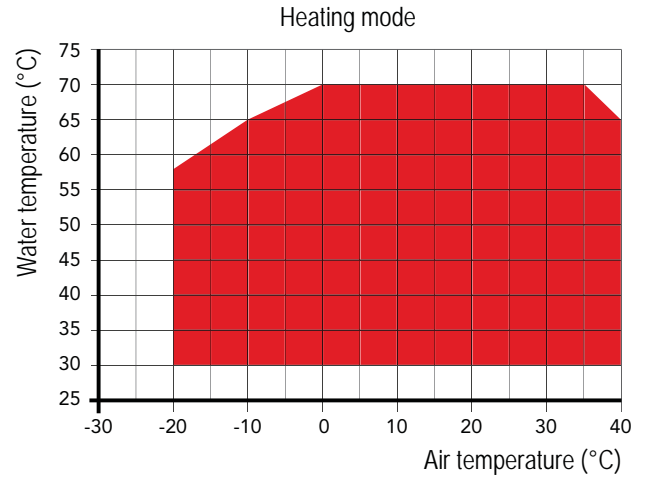
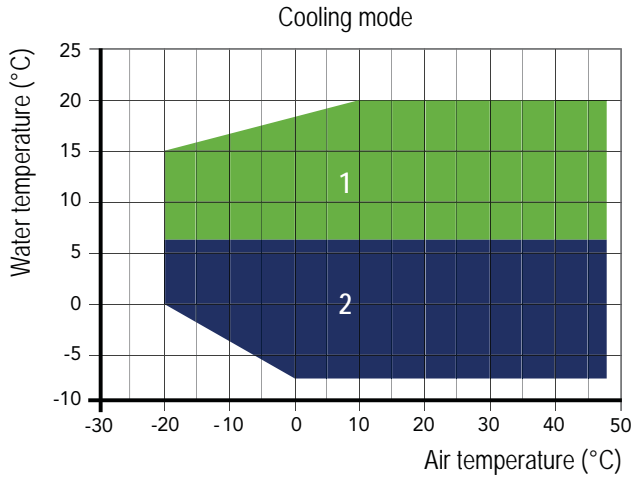

- 1 Cooling mode
- 2 Cooling with glycol

#### 3.5.2 PAE WA Kp

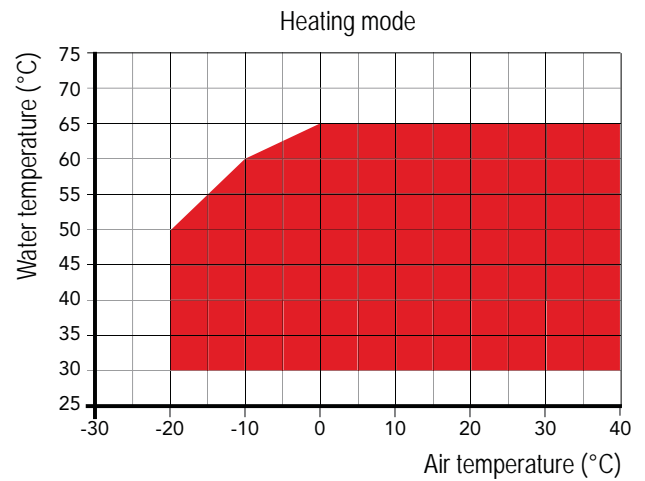
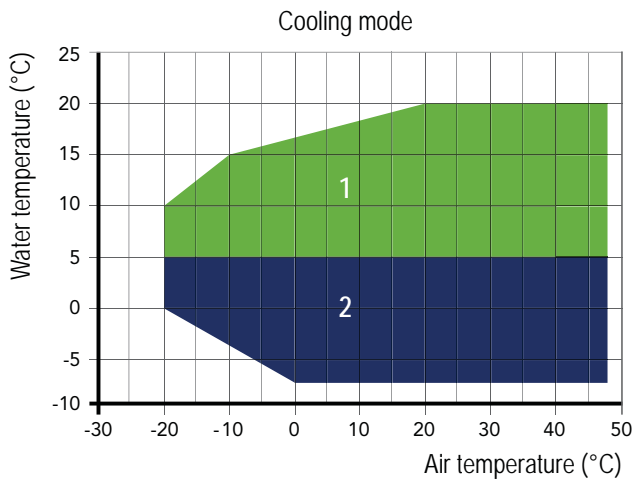

- 1 Cooling mode
- 2 Cooling with glycol

#### 3.5.3 GPE Kp

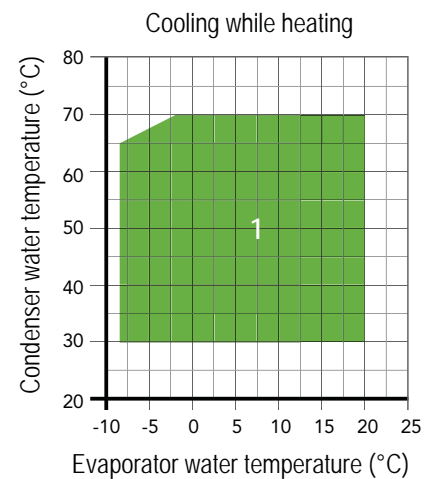
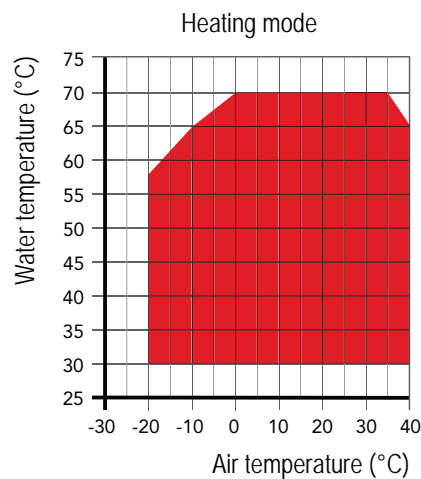
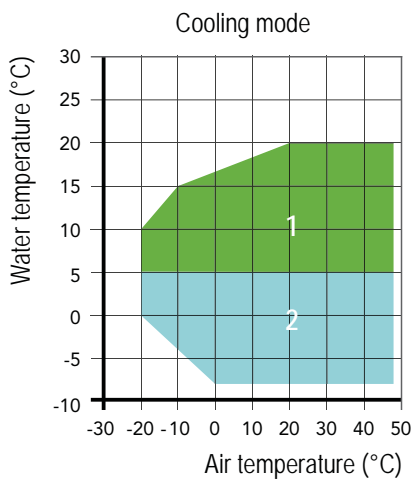

- 1 Cooling mode
- 2 Cooling with glycol

### 3.5.4 User heat exchanger water flow rate

The nominal water flow rate provided, relates to a  $\Delta T$  of 5K.

The minimum water flow rate allowed is that which results in a  $\Delta T$  of 7K. Insufficient flow will result in evaporating temperatures that are too low leading to the operation of safety devices that will prevent unit operation.



Units are designed and manufactured to European safety and technical standards. The units have been designed exclusively for cooling and DHW production. The units must be used for this specific purpose only. The Company will not be liable for claims for damage caused to persons, animals or material goods or property caused by improper installation, adjustment and maintenance or improper use. Any use not specified in this manual is prohibited.



In case of operations outside of these values, please contact the company.



If the unit is installed in particularly windy areas, it will be necessary to provide some windbreaker barriers to avoid any malfunction. We suggest to install the barriers only if the wind exceeds 2,5m/s.



The units, in their standard configuration, are not suitable for installation in saline environments.



### 3.6 Correction tables

#### 3.6.1 Operation with glycol

Glycol percentage	Freezing point (°C)	CCF	IPCF	WFCF	PDCF
10	-3,2	0,985	1	1,02	1,08
20	-7,8	0,98	0,99	1,05	1,12
30	-14,1	0,97	0,98	1,09	1,22
40	-22,3	0,965	0,97	1,14	1,25
50	-33,8	0,955	0,965	1,2	1,33

**CCF: Capacity correction factor**

**IPCF: Input power correction factor**

**WFCF: Water flow correction factor**

**PDCF: Pressure drops correction factor**

The water flow rate and pressure drop correction factors are to be applied directly to the values given for operation without glycol. The water flow rate correction factor is calculated in order to maintain the same temperature difference as that which would be obtained without glycol. The pressure drop correction factor takes into account the different flow rate obtained from the application of the flow rate correction factor.

#### 3.6.2 Correction tables different $\Delta t$

Water temperature diff.(°C)	3	5	8
CCCP	0,99	1	1,02
IPCF	0,99	1	1,01

CCCP = Cooling capacity correction factor

IPCF = Input power correction factor

#### 3.6.3 Correction tables different Fouling factors

Fouling factor	0,00005	0,0001	0,0002
CCCP	1	0,98	0,94
IPCF	1	0,98	0,95

CCCP = Cooling capacity correction factor

IPCF = Input power correction factor

### 3.7 Sound data



The sound data are calculated at the operating condition defined by EN 14511 for low-temperature air/water units in heating mode.

EVEREST 290											
Mod.	Octave bands (Hz)								Lw	Lp1	Lp10
	63	125	250	500	1K	2K	4K	8K	dB(A)	dB(A)	dB(A)
PAE 881 Kp	43	51	69	76	79	84	76	63	86,5	68,3	54,6
PAE 881 WA Kp	43	51	69	76	79	84	76	63	86,5	68,3	54,6
GPE 881 Kp	43	51	69	76	79	84	76	63	86,5	68,3	54,6

EVEREST 290		
Number of Modules	Lw	Lp10
	db(A)	db(A)
1	86,5	54,6
2	87,6	55,6
3	89,1	56,8
4	90,1	57,8
5	91,0	58,5

EVEREST 290		
Number of Modules	Lw	Lp10
	db(A)	db(A)
6	91,7	59,1
7	92,3	59,6
8	92,8	60,0
9	93,3	60,3
10	93,7	60,7

Lw: Sound power level according to ISO 3744.

Lp: Sound pressure level measured at 10 mt from the unit in free field conditions according to ISO 3744.

## 4. INSTALLATION

### 4.1 General safety guidelines and use of symbols



Before undertaking any task the operator must be fully trained in the operation of the machines to be used and their controls. They must also have read and be fully conversant with all operating instructions.



All maintenance must be performed by TRAINED personnel and be in accordance with all national and local regulations.



If the unit contains flammable refrigerant gas, the personnel authorized to carry out any operation on the unit must be adequately trained.



The installation and maintenance of the unit must comply with the local regulations in force at the time of the installation.



Avoid contact and do not insert any objects into moving parts.



It is recommended that natural and accidental events such as winds of abnormal force, seismic events, fire, abnormal precipitation including snowfall, lightning, flooding and inundation be considered during the design phase of the system according to current regulations.

### 4.2 Health and safety Considerations



The workplace must be kept clean, tidy and free from objects that may prevent free movement. Appropriate lighting of the work place shall be provided to allow the operator to perform the required operations safely. Poor or too strong lighting can cause risks.



Ensure that work places are always adequately ventilated and that respirators are working, in good condition and comply fully with the requirements of the current regulations.

### 4.3 Personal protective equipment



When operating and maintaining the unit, use the following personal protective equipment listed below as required by law.



Protective footwear.



Eye protection.



Protective gloves.



Respiratory protection.



Hearing protection.

## 4.4 Inspection

When installing or servicing the unit, it is necessary to strictly follow the rules reported on this manual, to conform to all the specifications of the labels on the unit, and to take any possible precautions of the case. Not observing the rules reported on this manual can create dangerous situations. After receiving the unit, immediately check its integrity. The unit left the factory in perfect conditions; any eventual damage must be questioned to the carrier and recorded on the Delivery Note before it is signed. The company must be informed, within 8 days, of the extent of the damage. The Customer should prepare a written statement of any severe damage.

Before accepting the unit check:

- The unit did not suffer any damage during transport;
- The delivered goods are conforming to what shown in the delivery note.

### In Case of Damage

- List the damage on the delivery note
- Inform the Company of the extent of the damage within 8 days of receipt of the goods. After this time any claim will not be considered.
- A full written report is required for cases of severe damage.

## 4.5 Transport and handling

In compliance with the EN 378-1, the unit can be identified as an indirect closed system, The refrigerant charge and type are indicated on the unit identification tag.

The unit handling must be done by skilled personnel only, with suitable equipment to the unit weight and dimensions. During the handling operations, keep the unit in vertical position (i.e. with the basement parallel to the ground)



The transport company is always responsible for any possible damage during the transport of the goods. Before installing the unit and preparing it for the commissioning, accurately sight inspect the unit to verify the packaging integrity or that the unit has no visible damage, and oil or refrigerant leakage. Also verify that the unit complies what required in phase of order.



Any possible damage or claim must be communicated to the Company or to the carrier by means of registered mail within 8 days from goods receipt.



If one or more components are damaged, do not start the unit, and immediately inform the Company, in order to agree any intervention on the unit.



It is suggested to unpack the unit at effective unit installation place. The internal handling must be done with care, avoiding using the equipment components as holds. Avoid any damage during the unit handling.



The hydraulic circuit must be fully empty before attempting to move the unit.



The units lifting must be vertical, preferably done by means of a forklift. Use a distribution beam if straps or ropes are used for the harness, carefully checking that no pressure is done on the higher edges of the unit or of the packaging.

**PAY ATTENTION:**

The refrigerant contained in the unit is flammable.

The unit can be installed outside only, away from any kind of possible ignition source.



### 4.6 Storage

If it is necessary to store the unit, leave it packed in a closed place. If for any reason the machine has already been unpacked, follow these instructions to prevent damage, corrosion and/or deterioration:

- Make sure that all openings are properly closed or sealed;
- Never use steam or other cleaning agents to clean the unit that could damage it;
- Remove any keys needed to access the control panel and entrust them to the site manager.



The unit can be stored at temperatures between -20°C and 65°C.



Exceeding the maximum storage temperature entails the risk of leakage of the refrigerant through the safety valve and the consequent formation of a potentially explosive mixture.



During the period of non-use, in order to prevent corrosive phenomena, deposits or breakages due to the formation of ice, it is of fundamental importance that the heat exchangers, on the utility side, are totally empty or completely full of adequately glycolated water.

### 4.7 Unpacking



Packaging could be dangerous for the operators.

It is advisable to leave packaged units during handling and remove it before the installation. The packaging must be removed carefully to prevent any possible damage to the machine. The materials constituting the packaging may be different in nature (wood, cardboard, nylon, etc.).



The packaging materials should be separated and sent for disposal or possible recycling to specialist waste companies.

## 4.8 Lifting and handling

The unit can be moved in the following ways:

**1. Using a forklift truck or forklift:** In this case, the unit must be pressed into the slots on the long sides of the base. The gripping points are protected by a yellow mask made of iron, the aim of which is to protect the painting of the base from the sliding of the forks. At the end of the handling operations, the masks can be removed.

**2. Using cranes or hoists:** In this case it is necessary to create an integral anchor by means of rope hooks or similar to the appropriate lifting brackets, available on request and supplied as a kit (optional MG).



In the absence of the above lifting brackets, the Company is relieved of any damage during handling and/or lifting operations by cranes, hoists or other lifting systems that involve the use of ropes and/or belts or similar.



Use a distributor beam if harness straps or ropes are used, making sure there is no pressure on the top edges of the unit or on the packaging.



When handling or lifting, the following must be performed:

- Make sure that the vehicle being used has sufficient load capacity;
- Make sure that the forks cross the entire width of the unit;
- Provide any protection to avoid damaging the unit;
- Avoid abrupt or violent manoeuvres;
- Make sure all the panels are closed;
- Use a distributor beam in case of lifting by means of belts to avoid pressures on the carpentry of the unit;
- Use means and/or devices in accordance with the law;
- Keep the unit horizontal; the maximum inclination must not exceed 5°;
- Comply with the current regulations and standards.

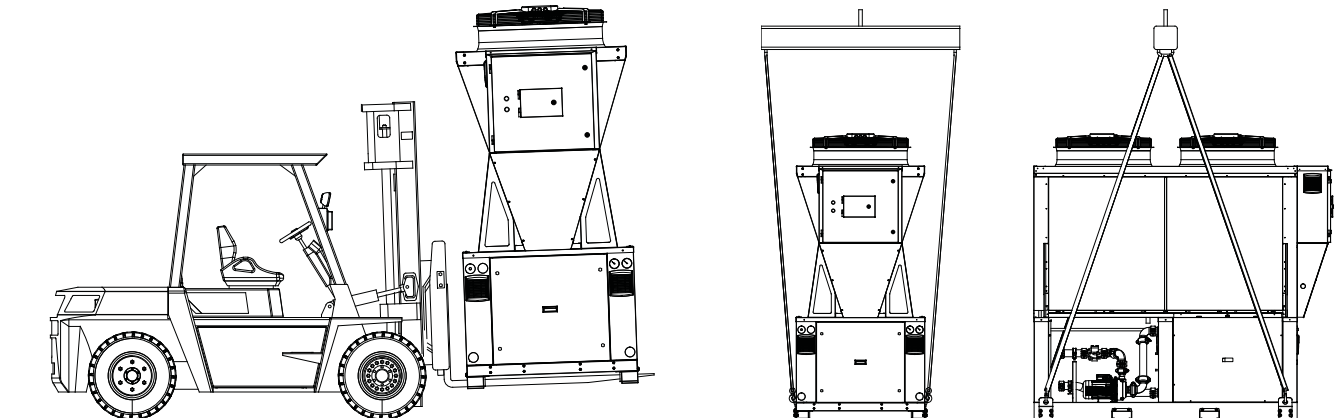

The Source heat exchangers fins are sharp. Use protection gloves.

## 4.9 Location and minimum technical clearances

All units are designed for external installation. Any overhang above the unit and location near trees, if they partially cover the unit, must be avoided in order to prevent air by-pass. Otherwise this could result in deterioration of the unit's performance or even the interruption of normal operation. In this regard, it is necessary to ensure the minimum service spaces indicated below.

The air flow in the coil is essential for proper operation of the unit. Therefore, the units should not be installed in environments in which foliage or dust can settle on the coil and obstruct the air flow should be avoided. It is also essential that no obstacles or barriers that could interfere negatively with the air flow are placed. If there are walls near the unit, it is compulsory to respect the minimum distances specified in the table; furthermore, there cannot be more than two contiguous walls and their maximum height must not exceed that of the fans of the unit. Any reflecting walls placed near the unit may increase the sound pressure measured.

Ideally create a support slab that is the correct size for the unit. The units transmit a low level of vibrations to the ground; however, it is advisable to interpose between the base frame and the support surface a number of anti-vibration supports.

The unit must be positioned as much far as possible, and anyway at 4 m minimum, from drainage or electrical systems, wells and drains, in order to avoid the spread of potentially explosive atmospheres, in case of refrigerant leakages.

For safety reasons, inside this area, no further devices, systems or ignition sources must be installed. Inside this area, the surfaces must not reach a temperature higher than 100 K from the auto-ignition temperature of the used refrigerant. If the unit is installed in a zone with Class A (Generic) or Class B (with Supervision) presences, in compliance with the EN 378-1, only the authorized person must be allowed near the unit, inside the spaces to be left free. In any case, all the systems nearby the unit, must be filled with sand or equipped with siphon. The underground pipelines must be positioned at 0.80 m under the ground level at least. The systems must be inspected every 6 months at least, in order to verify that the taken precaution to avoid the propagation of explosive atmospheres are efficient.



The group must be installed so that any possible refrigerant leakage cannot penetrate inside any building or closed ambient.



The unit has to be installed such that maintenance and repair is possible. The warranty does not cover costs for the provision of lifting apparatus, platforms or other lifting systems required to perform repairs during warranty period.



The installation site should be chosen in accordance with EN 378-1 and 378-3 standards. When choosing the installation site, all risks caused by accidental refrigerant leakage should be taken into consideration.



The unit must be anchored to the support base to avoid damage in the event of an earthquake or strong wind. In any case, if the area is frequently subject to strong wind, appropriate barriers must be provided to ensure the correct operation of the unit.



If snow accumulation is possible at the installation site, it is advisable to lift the unit at least 400 mm above the ground.



The installation site of the units must only be accessible to authorised personnel. Access to the public must in any case be prohibited.

#### 4.9.1 ATEX minimum technical spaces

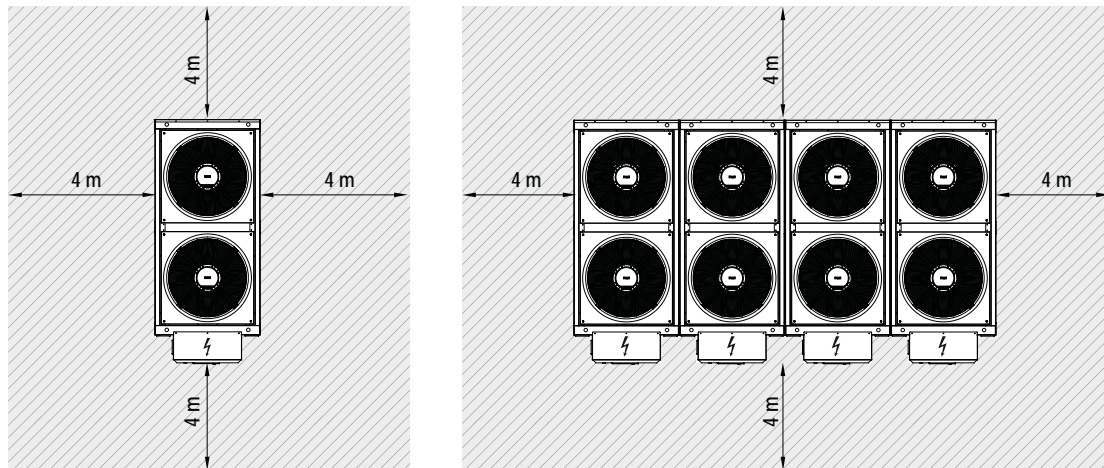

Within the minimum technical ATEX respect area, it is mandatory:

- Exclude all possible sources of ignition (electric arcs, free flames, hot surfaces, sparks, electrostatic charges, or other);
- Exclude the existence of manholes, slits or other places where refrigerant could accumulate in the event of a leak (consider that propane has a higher density than atmospheric and will therefore tend to settle).



The above-mentioned safety zone or recommendations can only be disregarded after a careful design and a specific risk analysis according to the current regulations by the plant designer. In this case, we recommend a periodic annual check on the correct functioning of the safety system introduced to deal with the above-mentioned cases. The company is not responsible for non-compliance with the ATEX minimum technical spaces.



In the case of a modular system, the refrigerant gas sensors of each unit must be connected to each other by the installer as described in the "Modular System Start-up" section.



In the case of a modular system, and in order to guarantee an adequate level of safety for the whole system, the alarm signal of one of the sensors causes all the units constituting it to go into an OFF state.

#### 4.9.2 Single unit minimum technical spaces

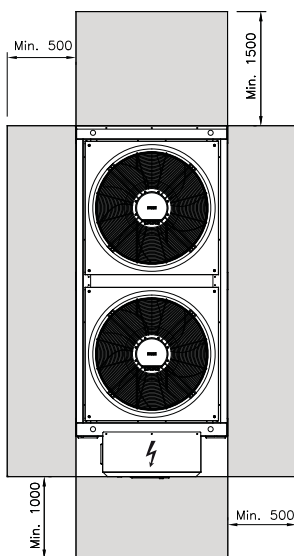

#### 4.9.3 Modular system minimum technical spaces

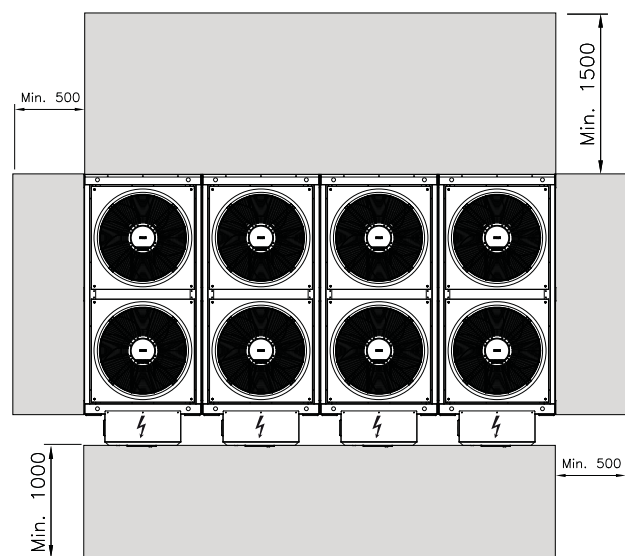

Within the minimum technical areas, it is necessary to exclude

- Any walls or obstacles to proper air flow (including acoustic barriers and sound-absorbing walls)
- Any element that may be an obstacle to the routine maintenance of the units



The distances indicated are the minimum needed to guarantee the correct functioning of the module or modular system. They are not those required for any extraordinary maintenance operations (such as the removal of one of the modules from the system) which must be evaluated not only according to the dimensions of the module but also by the lifting devices available and by the characteristics of the installation site.

#### 4.9.4 Connecting and positioning multiple units

The units of the EVEREST290 range are modular machines designed to work in parallel with each other, served by a single hydraulic circuit, up to a maximum of 10 units. If the installation involves such a configuration (modular system) the modules must be placed next to each other on a base that guarantees maximum stability and coplanarity to the entire system. Each module must be firmly anchored to the ground and the adjacent modules must be mechanically joined together using the fastening brackets supplied. The arrangement for the fixing of these brackets by means of screws is provided in the upper and lower edges on the front and rear side of each unit.

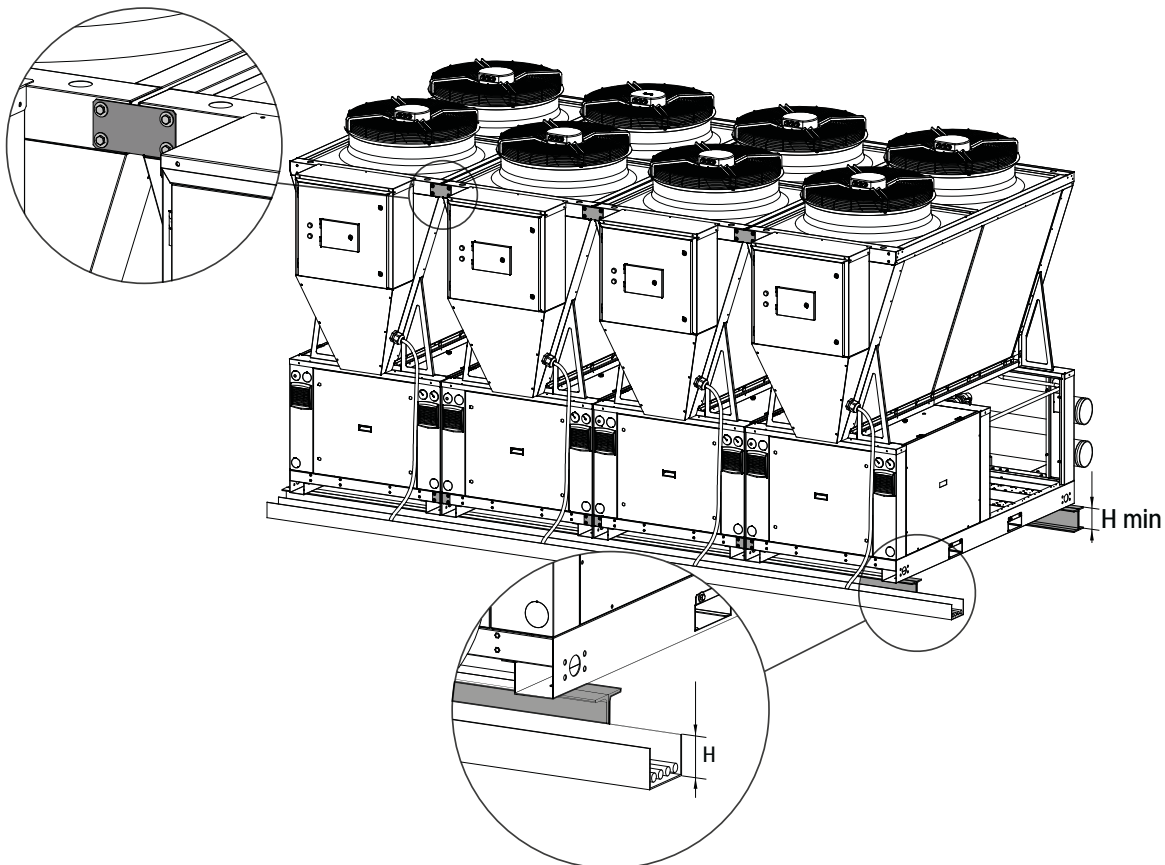

It is advisable to place the unit on a support base of height  $H_{min}$ , such that  $H_{min} > H$  where  $H$  represents the height of the electrical dorsal system created frontally on the ground with respect to the modular system. This means being able to remove the unit from the system without having to remove all the power cables of the other units.



Subsequently it is possible to continue with the creation of the water-side manifolds (KCA and KTT kit available on request).



Following the indications described in appendices A, B, C e D.

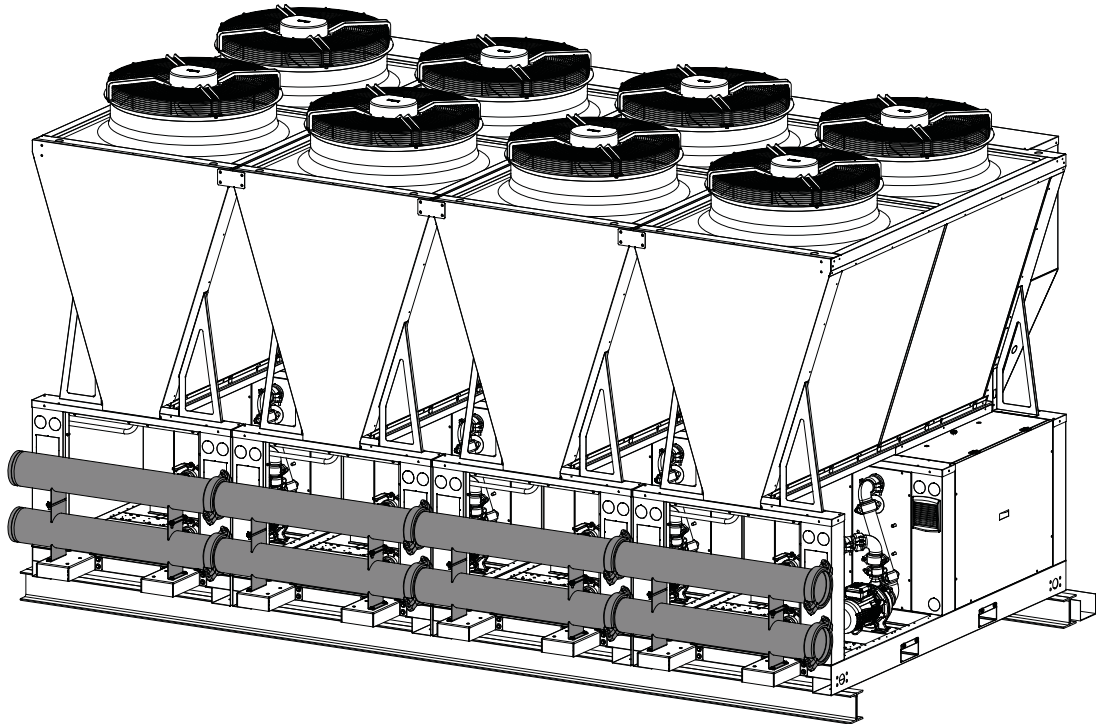

If the installation of the units takes place above a building, it is advisable to provide a system capable of attenuating vibrations and consequently the transmission of noise to the underlying premises (for example by means of shock absorbers or other anti-vibration systems)

#### 4.9.5 Installation of the heating cable



It is recommended that a heating cable be installed in the condensate drip tray discharge pipe to prevent freezing of the water inside the pipe itself, as this can lead to a malfunction of the unit.



The heating cable that is to be inserted in the discharge pipe must have a protection degree IP67 with a specific heating capacity of a minimum of 35W per linear metre. It is also recommended that the discharge pipe be insulated with closed cell type insulation having a minimum thickness of 15 mm.



Drive the condensate drain pipe to the level of the base frame in an area where no ice puddles occur near the unit.



The condensate drain pipe and the related heating cable are not supplied with the unit.

#### 4.10 Threaded Connection

EVEREST 290		
PAE 881 Kp	1/4" NPT	Safety valve
PAE 881 WA Kp	1/4" NPT	Safety valve
GPE 881 Kp	1/4" NPT	Safety valve

#### 4.11 Hydraulic connections

The water pipe-work must be installed in accordance with national and local regulation and can be made from copper, steel, galvanized steel or PVC. The Pipework must be designed to cater for the nominal water flow and the hydraulic pressure drops of the system, a maximum pressure drop of 300 Pa/m run being typical. All pipes must be insulated with closed-cell material of adequate thickness. The hydraulic piping of the unit or modular system should includes:

- Pockets for temperature sensor to measure the temperature in the system.
- Shut-off manual valves to isolate the unit from the hydraulic circuit.
- Metallic filters to be mounted on the inlet pipe with a mesh not larger than 1 mm.
- Venting valves (placed at the highest points of the circuit)
- Expansion vessel
- Loading station
- Safety valve (with cut-out pressure < 8bar)
- Unloading valve (placed at the lowest points of the circuit)



The hydraulic connection diameters are specified in the "Technical Data" table.



System return water must be fitted to the connection labelled: "USER WATER IN" as incorrect connection can damage the heat exchanger by freezing.



It is compulsory to install on the USER WATER IN connection, a water strainer with a mesh not larger than 1 mm. Fitting this filter is **COMPULSORY** and the warranty will be invalidated if it is removed. The filter must be kept clean and checked periodically.



The safety valve on the hydraulic circuit shall operate at a pressure not exceeding 8 bar. If you need that the unit works with higher pressures, please contact the Company.

The connection of the unit to the hydraulic circuit must be carried out by an experienced and qualified technician in accordance with the local regulations in force.



The connection of the unit to the system must be carried out in such a way that the fluid to be cooled circulates in the exchangers in the correct direction. To this purpose, the pipes must be connected in compliance with the instructions given in the connection on the unit.

To connect the pipes to the evaporator, take care of the following advises:

- Connect the pipes as shown in picture

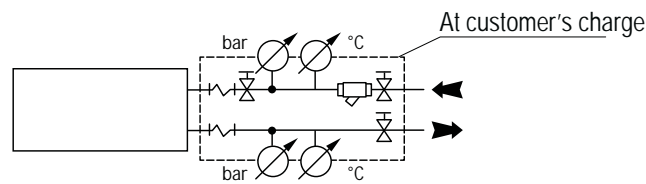

- To avoid any vibration transmission and permit the thermal expansions, anti-vibration fittings must be installed on the pipes. ;
- To avoid the inlet of foreign bodies and particles, you need to install, on unit inlet, a cleanable mechanic filter, with mesh dimension not larger than 1mm and with suitable nominal diameter, to reduce pressure drops;
- The installation of shut-off valve up and down stream of the filter is recommended, in order to make the cleaning operation simpler and quicker;
- The installation of thermometers and gauges near the inlet and outlet connection of the device, make the check of the unit operation easier;
- The chilled water system must be coated with close-cells anti-condensation material, with thermal insulation characteristics, vapor impermeability and with suitable thickness for the worst foreseeable conditions;
- Use the pre-arranged connection shown in the attached dimensional drawing to connect the unit to the hydraulic system;
- Once the circuit is done and the unit installed, seal test of the whole system must be done, in order to find out any possible leakage and repair it, before the circuit filling and commissioning.



After the seal test, if the start-up of the system is planned after a long period of stop or if the ambient temperature can go down till values near to 0°C or lower, you need to drain the water from the circuit or enter a suitable percentage of glycol.



If the unit is not to be used during the winter period, the water contained in the pipes may freeze and cause serious damage. In this event, fully drain the water from the pipes, checking that all parts of the circuit are empty including any internal or external traps and siphons.



In case of breaking of the user side exchanger, the refrigerant can enter the water circuit. Position then the vent valves of the system in airy zone and far from manholes where the refrigerant could be concentrated, creating potentially explosive atmospheres. If not possible, the closed ambient where these vent valves are present, must be arranged with the precautions stated in the EN-378.



The intervention of automatic degassers can generate a potentially explosive zone of spherical shape and radius  $\geq 2$  m. Therefore place these devices away from possible sources of ignition.



All units are factory supplied with a flow switch. If the flow switch is altered or removed the warranty will be invalidated.



When starting the unit for the first time, it is necessary to load it with clean water with chemical-physical characteristics such as to prevent corrosive phenomena or deposits of any kind. For this purpose, it is advisable to check annually the stability of the pH.

## 4.12 Hydraulic circuit

The units of the EVEREST290 range include a centrifugal pump on each of the plate heat exchangers present, with the aim of feeding the heat exchangers themselves with an adequate flow value of the heat transfer fluid in any operating condition. This design choice guarantees high stability and reliability of operation to the modular system. The heat exchangers of the units in operation in fact always work at constant flow values. In this way, the negative effects of the adjustment made by changing the supply flow of the heat exchangers themselves (suspensions, liquid returns to the compressors, problems related to the control logic) are cancelled.

The units switched off (partialised system operating speed) are completely by-passed by check valves and the relative pumps will be switched off.

The on-board pump has been sized to overcome the pressure drops inside the unit and allow the fluid to travel through the common manifold until reaching an inertial tank or an additional manifold, located in the immediate vicinity of the refrigeration unit. It is therefore essential to provide for booster systems of the carrier fluid arriving from the units or from the modular system towards the individual users through pumping units operating on the secondary circuit.

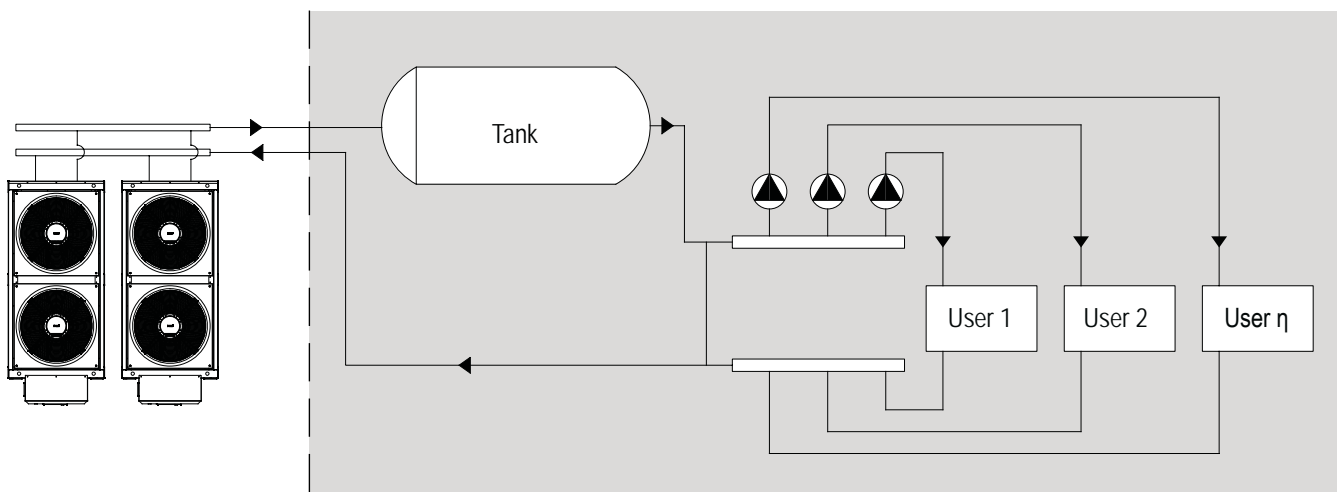

EVEREST290  
modular system

Installation site



It is absolutely forbidden to provide control/mixing systems that limit or interfere in any way with the input flow to the machines; the Company is not responsible in any way for problems related to control or operation and/or damage to the units.



The use of plant solutions other than those proposed relieves the Company of any responsibility.

### 4.13 Chemical characteristics of the water

In the following table there are, just as an indication, the main values of chemical and physical properties of the water to be respected to avoid corrosion or any sediment. To this purpose it is advisable yearly check PH stability.

<p><b>Table key</b></p> <p>+ Good resistance under normal conditions</p> <p>0 Corrosion problems may occur especially when more factors are valued 0</p> <p>- Use is not recommended</p>	<p><b>Important Note:</b> The following parameters can also influence the corrosion resistance</p> <p><u>Temperature:</u> The data in the table are based water temperature of 20°C unless otherwise is stated.</p> <p><u>Presence of oxidants</u> in the environment: guidelines regarding the oxygen content are shown in Table 3.</p> <p><u>Product form,</u> heat treatment and presence of intermetallic phases: The data in the table is based on untreated raw material.</p>
------------------------------------------------------------------------------------------------------------------------------------------------------------------------------------------	-------------------------------------------------------------------------------------------------------------------------------------------------------------------------------------------------------------------------------------------------------------------------------------------------------------------------------------------------------------------------------------------------------------------------------------------------------------------------------------

WATER CONTENT	CONCENTRATION (mg/l or ppm)	TIME LIMITS Analyze before	Plate Material		Brazing Material		
			AISI 304	AISI 316	COPPER	NICKEL	STAINLESS STEEL
Alkalinity (HCO <sub>3</sub> <sup>-</sup> )	< 70	Within 24 h	+	+	0	+	+
	70-300		+	+	+	+	+
	> 300		+	+	0/+	+	+
Sulphate <sup>[1]</sup> (SO <sub>4</sub> <sup>2-</sup> )	< 70	No limit	+	+	+	+	+
	70-300		+	+	0/-	+	+
	> 300		+	+	-	+	+
HCO <sub>3</sub> <sup>-</sup> / SO <sub>4</sub> <sup>2-</sup>	> 1.0	No limit	+	+	+	+	+
	< 1.0		+	+	0/-	+	+
Electrical conductivity <sup>[2]</sup> (Refer to Table 3 for oxygen content guidelines)	< 10 µS/cm	No limit	+	+	0	+	+
	10-500 µS/cm		+	+	+	+	+
	> 500 µS/cm		+	+	0	+	+
pH <sup>[3]</sup>	< 6.0	Within 24 h	0	0	0	+	0
	6.0-7.5		+	+	0	+	+
	7.5-9.0		+	+	+	+	+
	9.0-10		+	+	0/+ <sup>[4]</sup>	+	+
	>10.0		+	+	0	+	+
Ammonium (NH <sub>4</sub> <sup>+</sup> )	< 2	Within 24 h	+	+	+	+	+
	2-20		+	+	0	+	+
	>20		+	+	-	+	+
Chlorides (Cl <sup>-</sup> ) (Refer to Table2 for temperature- dependent values)	<100	No limit	+	+	+	+	+
	100-200		0	+	+	+	+
	200-300		-	+	+	+	+
	300-700		-	0/+	0/+	+	-
Free chlorine (Cl <sub>2</sub> )	< 1	Within 5 h	+	+	+	+	+
	1-5		-	-	0	+	-
	> 5		-	-	0/-	+	-
Hydrogen sulfide (H <sub>2</sub> S)	< 0.05	No limit	+	+	+	+	+
	>0.05		+	+	0/-	+	+
Free (aggressive) carbon dioxide (CO <sub>2</sub> )	< 5	No limit	+	+	+	+	+
	5-20		+	+	0	+	+
	> 20		+	+	-	+	+
Total hardness <sup>[5]</sup> (Refer to "Scaling Document" for scaling aspect of hardness effect)	4.0 - 11 °dH	No limit	+	+	+	+	+
	70 - 200 mg/l CaCO <sub>3</sub>		+	+	+	+	+
Nitrate <sup>[1]</sup> (NO <sub>3</sub> <sup>-</sup> )	< 100	No limit	+	+	+	+	+
	> 100		+	+	0	+	+
Iron <sup>[6]</sup> (Fe)	< 0.2	No limit	+	+	+	+	+
	> 0.2		+	+	0	+	+
Aluminium (Al)	< 0.2	No limit	+	+	+	+	+
	> 0.2		+	+	0	+	+
Manganese <sup>[6]</sup> (Mn)	< 0.1	No limit	+	+	+	+	+
	> 0.1		+	+	0	+	+

CHLORIDE CONTENT	MAXIMUM TEMPERATURE					
	20°C	30°C	60°C	80°C	120°C	130°C
= 10 ppm	SS 304	SS 304	SS 304	SS 304	SS 304	SS 316
= 25 ppm	SS 304	SS 304	SS 304	SS 304	SS 316	SS 316
= 50 ppm	SS 304	SS 304	SS 304	SS 316	SS 316	Ti
= 80 ppm	SS 316	SS 316	SS 316	SS 316	SS 316	Ti
= 200 ppm	SS 316	SS 316	SS 316	SS 316	Ti	Ti
= 300 ppm	SS 316	SS 316	SS 316	Ti	Ti	Ti
=700 ppm	SS 316	SS 316	Ti	Ti	-	-
=1000 ppm	SS 316	Ti	Ti	Ti	-	-
> 1000 ppm	Ti	Ti	Ti	Ti	-	-

In order to prevent corrosive phenomena or deposits of any nature it is recommended to:

- Empty the evaporator before any maintenance work is carried out;
- Do not clean the evaporator with unsuitable mechanical systems, such as drill bits or high-pressure jets;
- Do not clean with too aggressive cleaning agents. Before using a chemical detergent, check the compatibility with the construction materials of the exchanger.



In case of long stops, leave the heat exchanger completely filled with adequate glycol water or completely empty.

#### 4.13.1 Prevention of risk of freezing of the utility exchanger

The water contained inside the user exchanger, if not properly additivated, could freeze and consequently lead to the user exchanger breaking down. During operation of the unit this could occur due to insufficient water flow or too low water temperature. In order to prevent such situations from occurring, the unit is equipped as standard with a device that detects the presence of flow (differential pressure switch or vane flow switch) and an antifreeze probe placed on the water pipe out of the unit. Both devices provide for manual reset as a factory standard in the event of intervention.



It is compulsory to subject the aforementioned preventive devices (water differential pressure switch/flux switch and frost sensor) to periodic checks to ensure that they are functioning properly.



Tampering with and/or altering the above-described operation of the aforementioned preventive devices (water differential pressure switch/flux switch and frost protection probe) relieves the Company of any liability in the event of damage to the unit resulting from the freezing of the consumer heat exchanger.

#### 4.14 User circuit minimum water content



Heat pump units need a minimum water content inside the user circuit in order to guarantee the correct functioning of the unit. A correct water content reduces the n° of starts-and-stops of the compressors and this extends the operating life of the unit and allows a reduced reduction of the hot water temperature during the defrosting cycle. For these reason it's necessary to guarantee to the unit the following minimum water contents in the user circuit:  
Recommended minimum water content : 20 lt. x Thermal power ( kW ) / Number of compressors.

PAE 881 Kp	
<b>Minimum (l)</b>	900
PAE 881 WA Kp	
<b>Minimum (l)</b>	900
GPE 881 Kp	
<b>Minimum (l)</b>	900

#### 4.15 Filling the hydraulic circuit

- Before filling, check that the installation drain valve is closed.
- Open all pipework, heat pump and terminal unit air vents.
- Open the shut off valves.
- Begin filling, slowly opening the water valve in the filling group outside the unit.
- When water begins to leak out of the terminal air vent valves, close them and continue filling until the pressure gauge indicates a pressure of 1.5 bars.

The installation should be filled to a pressure of between 1 and 2 bars. It is recommended that this operation be repeated after the unit has been operating for a number of hours (due to the presence of air bubbles in the system). The pressure of the installation should be checked regularly and if it drops below 1 bar, the water content should be topped-up. If frequent top-ups are required, check all connections for leaks.

#### 4.16 Emptying the installation

- Before emptying, place the mains switch in the "Off" position.
- Make sure the filling group valve is closed.
- Open the drainage valve outside the unit and all the installation and terminal air vent valves.



If the fluid in the circuit contains anti-freeze, it **MUST** not be allowed to run away to drain. It must be collected for possible re-cycling or for correct disposal.



The exchangers treated with surface protection paint, even if protected against corrosion, must anyway be periodically inspected (never more frequently than 6 months under non-aggressive operating conditions, 3 months otherwise) to check the real condition of the surface protection. If it has been scratched or totally or partially damaged, the uncovered area must be once more protected with a new protective treatment.



If the unit is installed in strongly windy areas, near coasts or deserts or in areas subject to wind and/or sand storms, inspect the unit more frequently (every three months) to check the real condition of the surface protection.

#### 4.17 Electric connections: preliminary safety information

The electrical panel is located in the upper part of the unit on the front side opposite the hydraulic connections. To access the electrical panel, open the hatch using a dedicated key.



Power connections must be made in accordance to the wiring diagram enclosed with the unit and in accordance to the norms in force.



Make sure the power supply upstream of the unit is (fully isolated). Check that the main switch handle is padlocked and it is applied on the handle a visible sign of warning not to operate.



It must be verified that electric supply is corresponding to the unit electric nominal data (tension, phases, frequency) reported on the label in the front panel of the unit.



Power cable and line protection must be sized according to the specification reported on the form of the wiring diagram enclosed with the unit.



The cable section must be commensurate with the calibration of the system-side protection and must take into account all the factors that may influence (temperature, type of insulation, length, etc.).



Power supply must respect the reported tolerances and limits: If those tolerances should not be respected, the warranty will be invalidated.



Flow switches must be connected following the indication reported in the wiring diagram. Never bridge flow switches connections in the terminal board. Guarantee will be invalidated if connections are altered or not properly made.

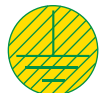

Make all connections to ground provided by law and legislation.



Before any service operation on the unit, be sure that the electric supply is disconnected.



The power line and the unit external safety devices must be sized in order to ensure the correct voltage at the maximum operating conditions of the unit reported in the wiring diagram of the unit.



##### FROST PROTECTION

If opened, the main switch cuts the power off to any electric heater and antifreeze device supplied with the unit, including the compressor crankcase heaters. The main switch should only be disconnected for cleaning, maintenance or unit repair.

The unit must be powered by a 4-wire cable (3 phases + GND), the power supply is 400 V/3PH/50 Hz. Connect the phases to the input clamp of the main switch and the ground conductor to the dedicated clamp. Use a power supply cable with suitable section and as short as possible to avoid voltage drops. Protect the power supply cable upstream the unit by means of an automatic switch with suitable size and features. The power supply cable section and the automatic switch size, are indicated in the paragraph dedicated to electrical data. The cable entry is shown in the dimensional drawing of the unit attached to the Handbook. It must be suitably protected in compliance with the local regulations in force. If the power supply cable entry is from the top, make a drop-break fold.





Before anyhow intervene on the unit, slightly verify that the electrical circuits of the device have not been damaged during the transport. Especially check that all the screws of the clamps are correctly tightened, and that the cable insulation is intact and in good conditions.

The conductors for the phases power supply cable, must be connected to the free clamps to the unit main switch entry; the ground conductor must be connected to the dedicated pre-arranged clamp (PE).

#### 4.17.1 Connection of power cables

Each unit must be powered by its own dedicated power cable coming from the electrical substation or from a general power concentrator panel that can be positioned near the units and that can be supplied on request in "KP5 or KP10" kits. In particular, in the case of a modular configuration, it is advisable to set up a single power supply dorsal system, for example by creating a dedicated duct, along the front side of the modular system below the support surface of the units. Doing so, if it is necessary to extract one of the modules from the system, this can be achieved by disconnecting it electrically and hydraulically disconnecting the individual module in question, allowing all the others to continue the service.

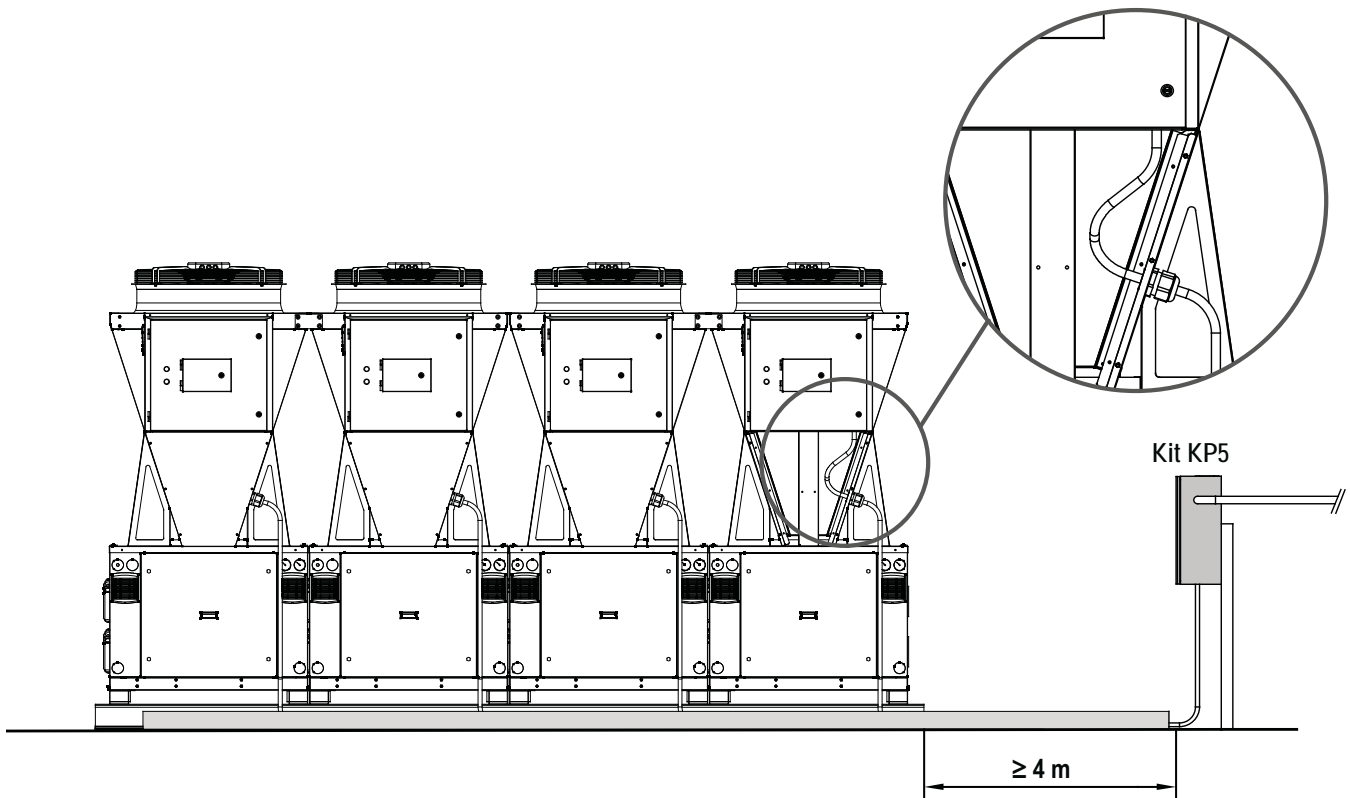

The electrical power cables must be physically separated from the mains and signal cables.

## 4.18 Electrical connections needed with a modular system

### 4.18.1 Connection of mains cables between multiple units

If the system involves the installation of a modular system then it is necessary to place the individual units in communication with each other. For this purpose, a gateway panel must be used ("KG5" kit if the system consists of 2 to 5 units, or "KG10" kit if the system consists of 6 to 10 units) to which each of the units present must connect through a data cable of the RJ45 ETHERNET type.



It is suggested that kits that enable communication between units or interface with units (KG5/10, KGH5/10, KGR5/10) be powered by a dedicated cable in order to keep the system fully functional even if the module housing the kit is not powered.



It is recommended to install the "KG5 or KG10" kit on one of the two units external to the modular system. In this case the removal of one of them from the system, does not involve the remaking of the network cables of the units present. It will be necessary:

- Disconnect the Ethernet and power cables of the "KG5 or KG10" kit from the electrical panel of the module to remove.
- Disassemble the "KG5 or KG10" kit and to reassemble it on the module adjacent to the one removed.
- Connect the Ethernet cable previously removed to the electrical panel of the module on which the kit is now located, and restore the power supply to the "KG5 or KG10" kit.



If KGR5/10 or KG5/10 is present, we suggest to install the panel with the router in the module adjacent to the external module on which the KG5/10 panel will be mounted



The tablet interface kit (KTA), if provided, will be installed on the same module as the panel containing the router.

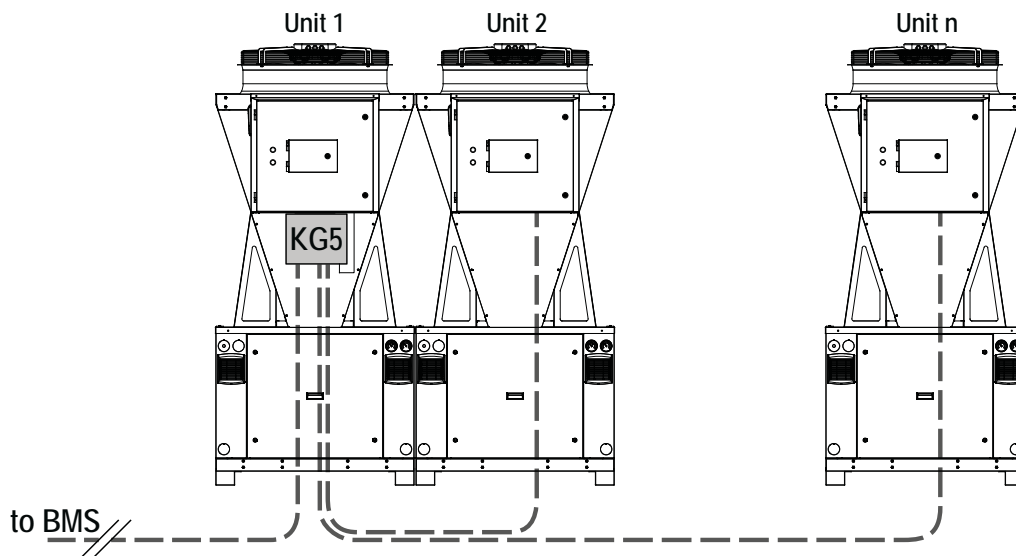

For detailed information on the assembly and wiring of the gateway panel refer to dedicated paragraph within the manual.

For each of the units constituting the modular system it is necessary to provide a network cable that connects the Ethernet port of the controller on the machine to one of the ports present in the switch installed inside the "KG5 or KG10" kit that collects all the network cables of the system.



The supply and wiring of all electrical connections (power or data transmission) connecting any kit to EVEREST290 units are not included with the kit supply.



The data cable to be used must be suitable for external installations UV-resistant and in any case suitable for the environmental conditions envisaged at the installation site.



A non-inverting Ethernet cable of at least category 6 (or 6a in the case of lengths of more than 50 metres) is recommended.

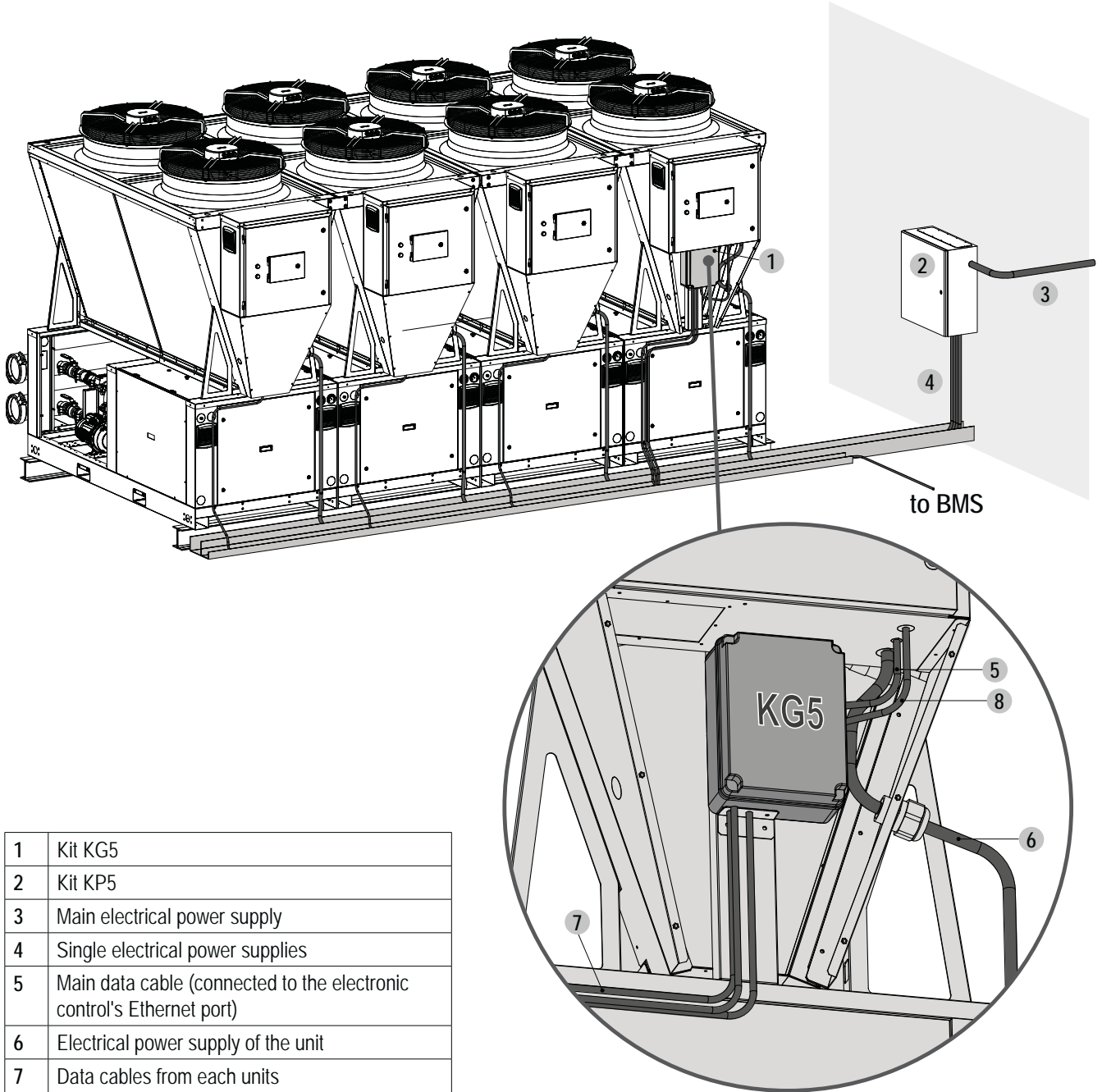

1	Kit KG5
2	Kit KP5
3	Main electrical power supply
4	Single electrical power supplies
5	Main data cable (connected to the electronic control's Ethernet port)
6	Electrical power supply of the unit
7	Data cables from each units
8	Electrical power supply of KG5 Kit



The data cables must be physically divided by the power cables. It is necessary to create a dedicated duct to avoid malfunctions due to electromagnetic disturbances.

#### 4.18.2 Connection of sensor alarm signal between two or more units

If the installations provide the use of a modular system, it is mandatory to connect all the existing refrigerant gas sensor alarm contacts reciprocally.

These electrical connections must be made as indicated below and following the instructions in the wiring diagram supplied with the unit:

1. Remove the bridge between inputs "341-341X" from the electrical panel terminals.
2. This operation must be carried out on all modules present, taking care to remove only 1 of the 2 jumpers on the indicated inputs.
3. Connect the digital output ( potential-free contact) U20-U21 with the inputs "341-341X" of the next machine in a reciprocal manner between all modules present (as shown below)

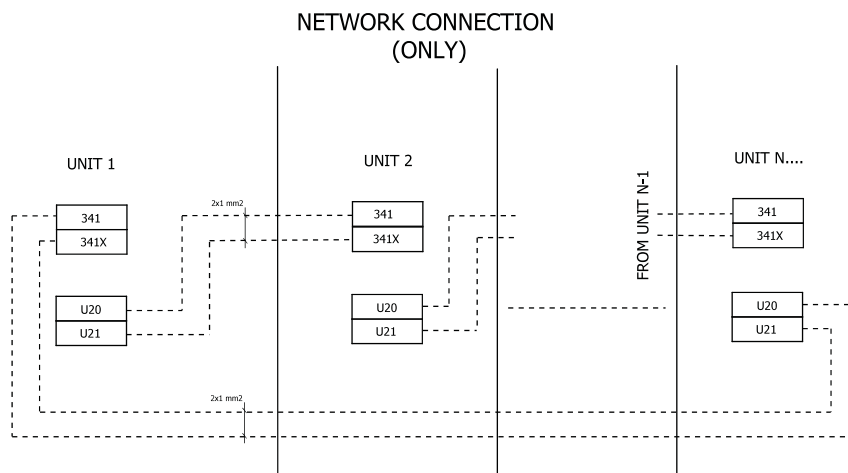

The missing connections described above do not guarantee the safety of the entire system in case of a refrigerant leak and absolve the manufacturer from any liability arising therefrom.



To ensure the operation of the modular system, all units must be powered and none of the refrigerant gas sensors must be in alarm

#### 4.18.2 KNS kit connection (network starter kit)

In association with the KG5/KG10 kits, which must be provided in the case of a modular system, the KNS device is supplied, which enables the automatic reset of the entire system following a blackout. The device is already wired with the numbered cables and can be installed on either of the units of the modular system. For electrical wirings, inputs "341-341X" must be used after removing the existing jumper and following the instructions in the wiring diagram supplied with the unit.

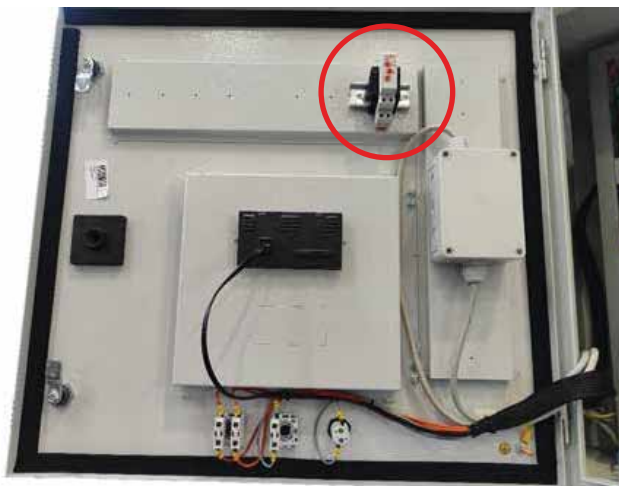



The missing connections described require the intervention of a qualified technician to reset the system following a blackout, who must follow the start-up procedure described in the dedicated paragraph.

#### 4.18.1 Preparing the IH/IWG cable passage (optional)

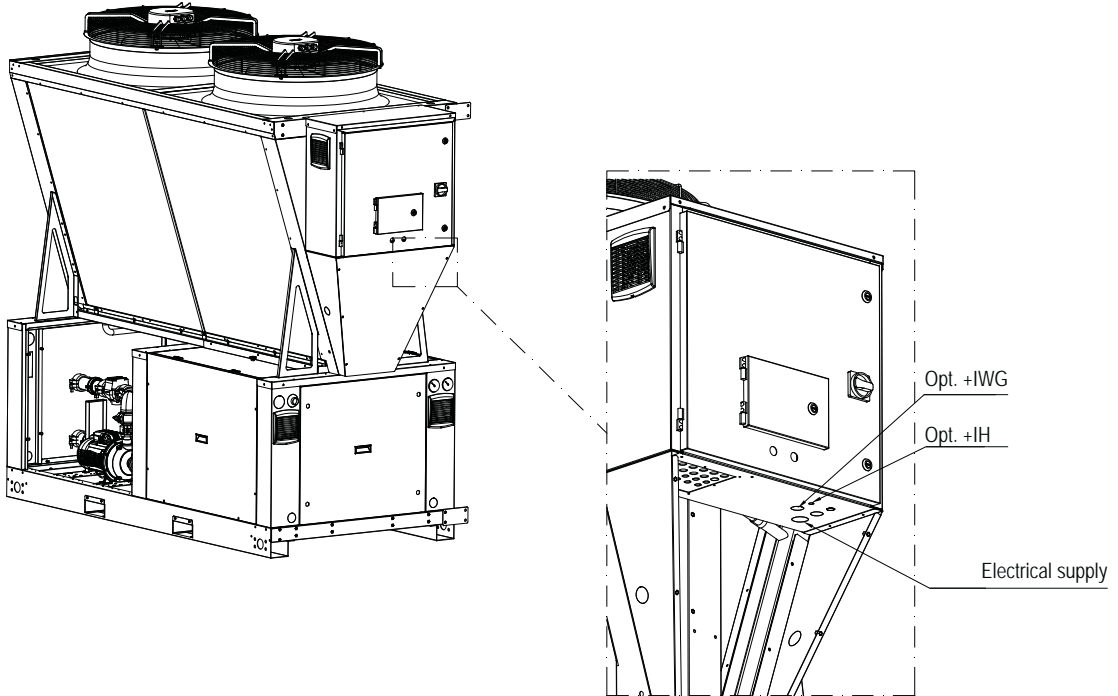

#### 4.19 Electric data



Refer to the data reported in the attached electrical wiring diagrams.



The line voltage fluctuations can not be more than  $\pm 10\%$  of the nominal value, while the voltage unbalance between one phase and another can not exceed 2%. If those tolerances should not be respected, please contact our Company. The use of the unit with a power supply with higher variations than those indicated will invalidate the warranty.

EVEREST290		PAE 881 Kp	PAE 881 WA Kp	GPE 881 Kp
Power supply	V/-/ Hz	400/3/50 + GDN	400/3/50 + GDN	400/3/50 + GDN
Control board	V	24	24	24
Auxiliary circuit	V/- - V	230/1-24	230/1-24	230/1-24
Fans power supply	V/-	400/3	400/3	400/3
Line section	mm <sup>2</sup>	25	25	25
PE section	mm <sup>2</sup>	16	16	16
Main switch	A	80	80	80
	-	3 poles	3 poles	3 poles
	Curve	"D"	"D"	"D"

In the case of a modular system, the electrical cables that exit the power concentrator panel (opt. KP5 / KP10) going towards the substation must have the following minimum sections:

EVEREST290 combined modules	n°	2	3	4	5	6	7	8	9	10
Line section	mm	70	120	150	2x120	2x150	2x150	2x185	3x150	3x185
PE section	mm	50	70	95	2x70	2x95	2x95	2x120	2x120	2x150



Electric data may change for updating without notice. It is therefore necessary to refer always to the wiring diagram present in the units.

## 5. UNIT START UP

### 5.1 Preliminary checks

Before starting the unit the checks detailed in this manual of the electric supply and connections, the hydraulic system and the refrigerant circuit, should be performed.



Start-up operations must be performed in accordance with the instructions detailed in the previous paragraphs.



If it is required to switch the unit on and off, never do this using the main isolator: this should only be used to disconnect the unit from the power supply when the unit is to be permanently off. Isolation will result in no supply for the crankcase heater and on start up the compressor could be seriously damaged.

#### 5.1.1 Before start-up



Damage can occur during shipment or installation. It is recommended that a detailed check is made, before the installation of the unit, for possible refrigerant leakages caused by breakage of capillaries, pressure switch connections, tampering of the refrigerant pipework, vibration during transport or general abuse suffered by the unit.

- Verify that the unit is installed in a workmanlike manner and in accordance with the guidelines in this manual.
- Check that all power cables are properly connected and all terminals are correctly fixed.
- The operating voltage between phases R S T is the one shown on the unit labels.
- Check that the unit is connected to the system earth.
- Check that there is no refrigerant leakage.
- Check for oil stains, sign of a possible leak.
- Check that the refrigerant circuit shows the correct standing pressure on the pressure gauges (if present) otherwise use external ones.
- Check that the Schrader port caps are the correct type and are tightly closed.
- Check that crankcase heaters are powered correctly (if present).
- Check that all water connections are properly installed and all indications on unit labels are observed.
- **The system must be flushed, filled and vented in order to eliminate any air.**
- Check that the water temperatures are within the operation limits reported in the manual.
- Before start up check that all panels are replaced in the proper position and locked with fastening screws.



Do not modify internal wiring of the unit as this will immediately invalidate the warranty.



Crankcase heaters must be powered at least 12 hours before start up (pre-heating period) To do this, isolate the compressor(s), fans and pump(s) in the electrics box and then switch on the main isolator (heaters are automatically supplied when the main switch is closed). The crankcase heaters are working properly if, after several minutes, the compressor crankcase temperature is about 10÷15°C higher than ambient temperature.



During the 12 hours pre-heating period it is also important to check that the label OFF is shown on the display or that the unit is on stand-by mode. If there is an accidental start-up before the 12 hours pre-heating period has elapsed, the compressors could be seriously damaged and therefore the warranty will immediately terminate .

#### 5.1.2 Commissioning

The unit commissioning must be carried-out by a skilled refrigeration technician authorized by the manufacturer.



Before turning on the unit, please check that the taps located on the discharge and suction pipe of the compressors are open.



After opening the taps located on the compressors, the unit must be immediately turned on.



Before starting the unit for the first time or after a long period of stop, verify that the parameters set on the micro-processor are coherent with the required working conditions.

On the electrical panel of all units there is a 3-position selector switch that must be used in specific circumstances. The positions provided by the selector switch are as follows:

- **0:** Selector switch position during normal operation of the unit.
- **1: Power on/off**  
To be used only in the case of modular systems:
  - A. If it is necessary to switch off one unit of the modular system while keeping the others operational, move the selector switch of the unit to be excluded to position 1 before turning the main switch to OFF
  - B. During start-up, as described in the dedicated paragraph "Starting up the modular system".

After completion of the above operations, the selector switch must be moved back to position 0.

- **2: Sensor test**  
This is the position the selector must be set to in order to access the "Check sniffer alarm" mode as described in the dedicated paragraph "Periodic checks of the refrigerant gas detection sensor".

After completion of the above operations, the selector switch must be moved back to position 0.

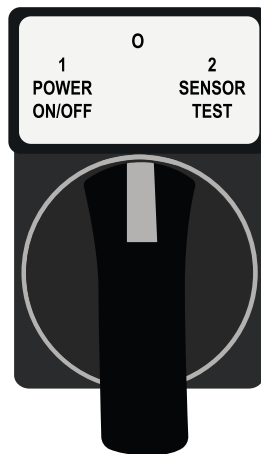

In order to ensure the level of safety required by the entire modular system, it is of paramount importance that the selector switch is in position 0 during normal operation.

### 5.1.3 Single Unit Start-up

Before powering the installed module in single configuration, it is required:

1. Check the presence of jumpers between the 2 "341-341X" inputs on the terminals box
2. Check that the selector switch on the front of the electrical panel is in position 0
3. Switch the unit on by turning the main switch to the ON position
4. The refrigerant gas sensor starts the initialisation phase (lasting approximately 300seconds), which ends when the red light on the front of the electrical panel turns off
5. Press the ON/OFF button on the microprocessor keyboard and switch it to ON to allow the unit to start up according to the thermal load required by the system and the set-point



#### 5.1.4 Modular system Start-up

Once all electrical connections required in the case of a modular system have been made (mains cables, alarm signal), the system can be started up.

1. Move the selector switch on the front of the electrical panel of each module to position 1 (power on/off)
2. Switch on each of the modules by turning the individual main switches to the ON position.
3. The refrigerant sensors installed on each of the modules now enter the initialisation phase (lasting approximately 300seconds), which ends when all the red lamps on the front of the switchboards are switched off
4. Switch the selector switch on the front of the electrical panel of each module to position 0

Enter the displays of each module, press the ON/OFF button on the microprocessor keyboard and switch it to ON to enable each of the units present to start up in accordance with the thermal load required by the system and the set-point

If the remote ON/OFF contact is closed, the circulation water pump, if present, will immediately start. After a delay time, settable by microprocessor, also the fans will start and then the different compressors in relation to the required cooling capacity to satisfy the present thermal load.

Once the unit has reached a stable operation regime, the technicians must verify the group working parameters and verify that:

- a) the safety high pressure switches are right installed and calibrated;
- b) on the external safety valves it is shown the calibration pressure and that the value is the one foreseen.
- c) No refrigerant leakage is present

The collected data must to be recorded on the commissioning report.



A copy of the commissioning report, duly filled, must be sent to the Company, to make the warranty valid.



During the commissioning, the technician must check that the safety (high and low pressure switches, water differential pressure switch, anti-freeze thermostat etc.) and control devices (regulation thermostat, condensation pressure regulation device etc) properly work.

### 5.1.5 Device and security Set-point

Device		Set-point	Differential	Reset
Cooling mode	°C	12 *	4	----
Heating mode	°C	45 *	4	----
Anti-freeze thermostat	°C	6	4	Manual
Fire prevention safety valve	Bar	25	----	----
High pressure switch compressors stop	Bar	30,5	----	Manual
Low pressure transducer	Bar	3,5	----	Automatic

\* Default values.

### 5.1.6 Controls during unit operation

- Check the rotation of the compressors and fans. If the rotation is incorrect, disconnect the main switch and change over any two phases of the incoming main supply to reverse motor rotation (only for units with three-phase fan motors).
- After several hours of operation, check that the sight glass has a green colour core: if the core is yellow moisture is present in the circuit. In this event it is necessary for dehydration of the circuit to take place. This must be performed by qualified people only. Check that there are no continuous vapour bubbles present at the sight glass. This would indicate a shortage of refrigerant. A few vapour bubbles are acceptable.

## 5.2 Operation of the refrigerant gas detection sensor

### 5.2.1 Starting the unit

Each time the unit is switched on (Power-On), a self-calibration procedure is carried out on the sensor which lasts 300 seconds. During this time:

- The refrigerant leakage alarm is signalled by means of a red light alarm on the front of the electrical panel
- The 24 Vac auxiliary circuit and the 230 Vac circuit are not powered
- The forced ventilation of the compressor compartment by means of the ATEX emergency fan is activated.

If the procedure is successful, the sensor becomes operational and immediately:

- The red light alarm on the front of the electrical panels goes out
- All auxiliary circuits are powered
- The forced ventilation of the compressor compartment by means of the ATEX emergency fan is deactivated

The unit is in ON mode and it is ready to start.



In the case of a modular system and with the aim of ensuring the safety of the entire system, all refrigerant gas sensors are in communication with each other via the electrical connection, which the installer must carry out as described in the section entitled "Modular system Start-up".

### 5.2.2 Sensor operation (single unit installation)

The operation of the sensor is based on two alarm thresholds:

- Lower threshold set at 20% LFL (Lower Flammable Limit) with automatic alarm reset
- Upper threshold set at 30% LFL (Lower Flammable Limit) with manual alarm reset

If, during normal unit operation, the sensor detects a refrigerant concentration above the threshold values, an alarm is activated in the unit (it switches OFF) and immediately:

- The refrigerant leakage alarm is signalled by means of a red light alarm on the front of the electrical panel
- The 24 Vac auxiliary circuit and the 230 Vac circuit are disconnected from the power supply
- The forced ventilation of the compressor compartment by means of the ATEX emergency fan is activated

This situation persists until the sensor is reset; this can either occur automatically or it must be done manually depending on the threshold value exceeded.

#### Automatic sensor reset

This occurs only if the refrigerant concentration in the air detected by the sensor drops below the lower threshold, without having exceeded the upper threshold.

In this case, the sensor alarm disappears automatically:

- The red light alarm on the front of the electrical panels goes out and the U20-U21 contact switches;
- All auxiliary circuits are reactivated;
- The forced ventilation of the compressor compartment by means of the ATEX emergency fan is stopped.

The unit returns to ON mode and it is ready to start.

#### Manual sensor reset

If the upper limit is exceeded, after having identified and solved the problem that generated it, the alarm can be reset by turning the main switch (power supply OFF/ON). The sensor will then perform the self-calibration procedure after which (with a positive outcome) the unit will return to ON mode and will be ready to start up compatibly with the thermal load required by the system and the set-point.

#### 5.2.3 Sensor operation (modular system)

The operation of the sensor is based on two alarm thresholds:

- Lower threshold set at 20% LFL (Lower Flammable Limit) with automatic alarm reset
- Upper threshold set at 30% LFL (Lower Flammable Limit) with manual alarm reset

If during normal operation of the modular system, the sensor detects a refrigerant concentration above the threshold values, an alarm is activated in the unit (it switches OFF) and immediately:

- The refrigerant leakage alarm is signalled by means of a red light alarm on the front of the electrical panel of the unit that generated the alarm
- The 24 Vac auxiliary circuit and the 230 Vac circuit of all the units forming the system are disconnected
- Forced ventilation of the compressor compartment is activated via the ATEX emergency fan of all the units making up the system

In order to reset normal operation of the modular system, after identifying and solving the problem that generated it, manual intervention must be carried out as described in the section "Resetting the modular system after a sensor alarm".

#### Automatic sensor reset

This occurs only if the refrigerant concentration in the air detected by the sensor drops below the lower threshold, without having exceeded the upper threshold.

In this case, the sensor alarm disappears automatically:

- The red light alarm on the front of the electrical panels goes out
- All units in the modular system are in the OFF position with forced ventilation of the compressor compartment by means of an active ATEX emergency fan
- The leak must be identified by using a sniffer on each of the units of the modular system or by checking the pressure detected by the pressure gauges on board the single units (available on request - opt. MT)
- After identifying and solving the cause that generated the alarm, it is possible to proceed with the reset procedure of the modular system as described below

#### Manual sensor reset

If the refrigerant concentration in the air detected by the sensor has exceeded the maximum limit:

- The red light alarm on the front of the control panel of the unit that generated the alarm is still active
- All units of the modular system are in the OFF state with forced ventilation of the compressor compartment by means of an ATEX emergency fan active
- The leak must be identified using a sniffer, focusing attention on the unit in alarm status (red light on) or by checking the pressure detected by the pressure gauges on the unit (available on request - opt. MT)
- After identifying and solving the cause that generated the alarm, it is possible to proceed with the reset procedure of the modular system as described below

#### Resetting the modular system after a sensor alarm

To reset the entire system to normal operating conditions, it is necessary:

1. One by one move the selector switches of all units present to position 1 (power on/off)
2. If the alarm occurred due to the upper limit being exceeded, then wait for the end of the initialisation phase of the sensor that generated the alarm (which will be signalled by the red lamp on the front of the switchboard going out) otherwise go directly to the next step
3. Move the selector switches of all units one by one to position 0



Before resetting the alarm signalled by the refrigerant gas sensor and restoring normal operation of the unit or modular system, it is essential to identify and eliminate the causes that generated it.



It is very important to reset the sensor after all traces of refrigerant have been dispersed from the compressor compartment, and that the sensor starts the self-calibration procedure in the environmental conditions in which it will normally operate.

**Ambient air (normal functioning)**



Temperature  
No gas  
Pressure  
Humidity

**Ambient air**



Temperature  
No gas  
Pressure  
Humidity

**Ambient air + R290**



Temperature  
Propane  
Pressure  
Humidity

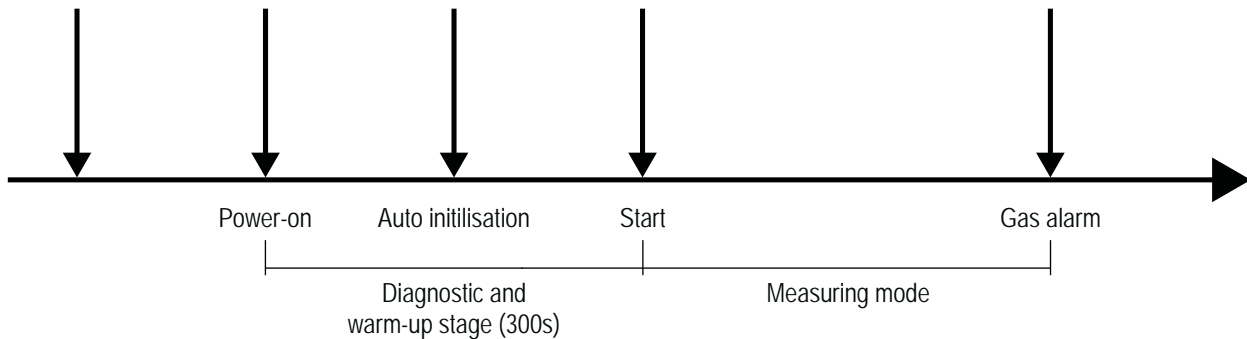

By means of the "U20-U21" contact in the terminal block of the electrical panel, it is possible to use the alarm signal of the leak detection sensor, for example to disconnect the power supply to one or more appliances located near the unit. This is a normally open and voltage-free contact. If the sensor is not in the alarm condition, the contact is closed; it opens if unit is not powered or if the sensor is in the alarm condition. **The contact is only available when installing units in a single configuration.**



The sensor uses technology that does not require mandatory periodic calibrations. It is necessary to perform periodic visual and functional checks to make sure that the system is in perfect working order. These checks must be performed by personnel qualified to work on circuits containing flammable refrigerant gases, according to the methods and frequency described in the dedicated section of this manual ("Periodic checks of the refrigerant gas detection sensor").



During normal operation, the ventilation of the technical compartment is forced cyclically for 2 minutes every 20 hours.



If the periodic maintenance checks are not performed on the leak detection sensor within the required times, the unit will go into lockout. For further details, refer to the dedicated paragraph ("Periodic checks of the refrigerant gas detection sensor").



If the leak detection sensor is tampered with, if the required checks are not performed, or if non-original components are used or connections not in accordance with the design documents after made after maintenance work, the Company is automatically relieved of any liability related to any malfunctions.

### 5.3 Safety valves

The units have a safety valve positioned on the low pressure branch.

	Outlet diameter	Intervention pressure
VS Low pressure	1" GF	25 bar

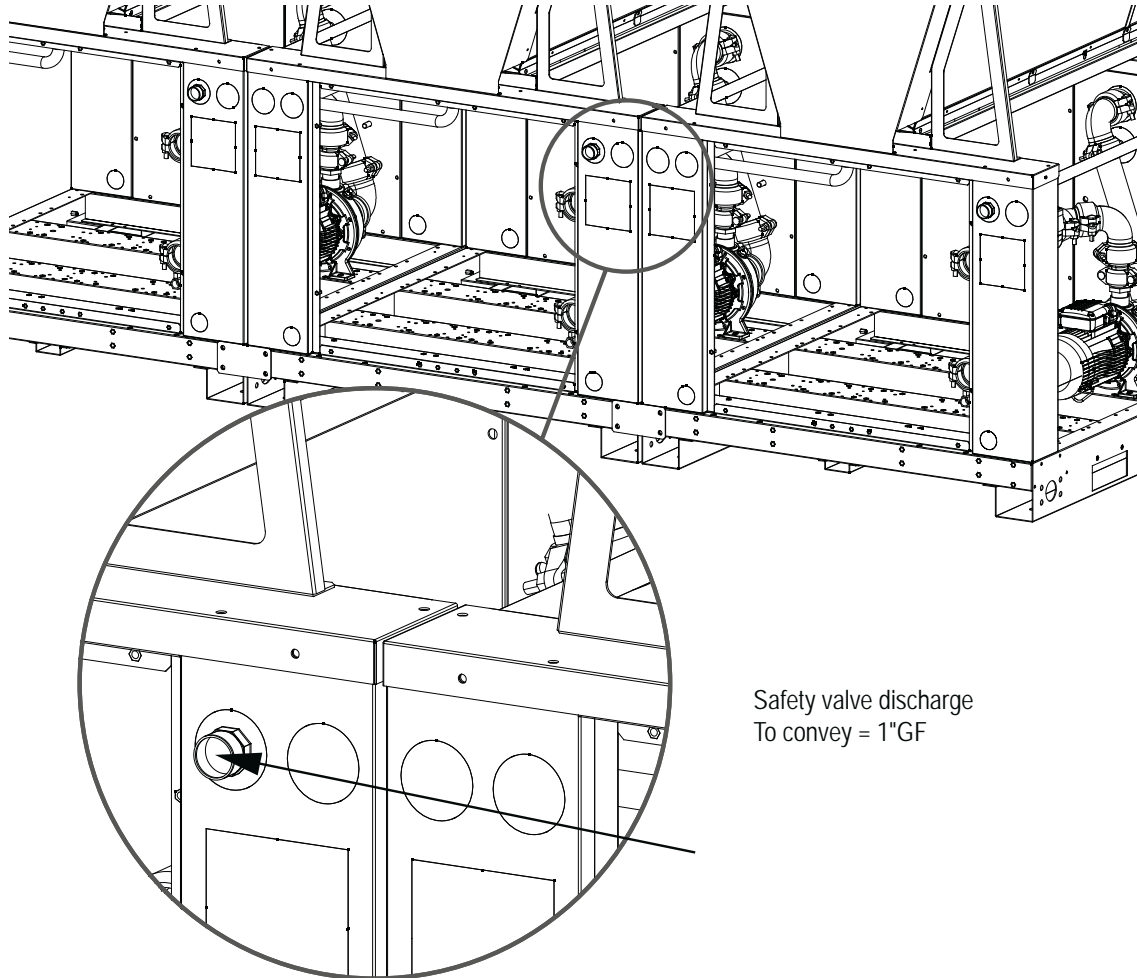

The outlet connections of the safety valves installed on the unit are provided with a threaded connection, which must be connected to a safe area at a height of not less than 4 metres from the condenser or at a distance of at least 4 metres from the machine and any other sources of ignition. If provided, the valves must be directed in metal piping, to an area where the refrigerant spill cannot damage people or things. The piping must be made according to the EN378 and EN13136 regulations and to any regulations in force.



The piping for conveying into a safe area must allow the release of the refrigerant upwards, away from the machine, from potential triggers from doors, windows or other entrances to closed environments.



The refrigerant spilled from safety valves is an high pressure, high temperature and high speed discharged gas. Its flow may damage things and people coming in direct contact with it.



The opening of safety valves comes with a noise whose intensity may damage hearing capabilities of surrounding people.



The representative cone that forms following the opening of the safety valve can expand for more than 10m from the release point.



Activation of the safety valve creates an area around the discharge in which a flammable atmosphere can be created. Ensure that there are no obstacles or ignition sources in the cone area below.

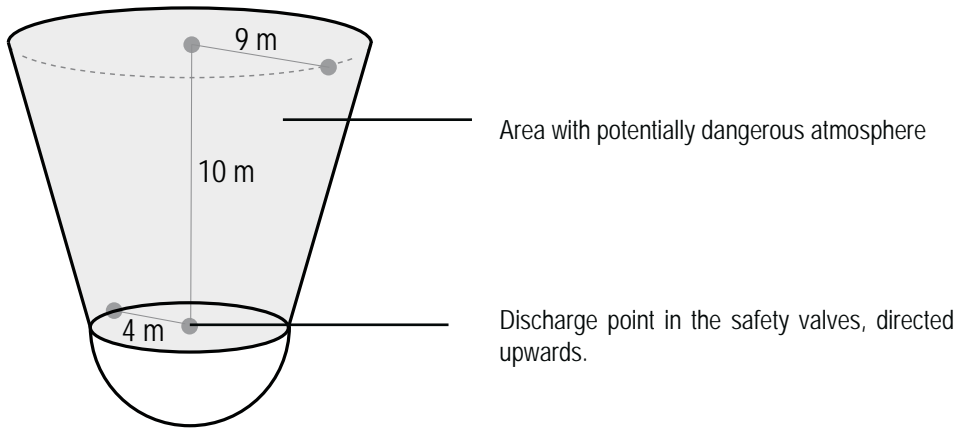

Possible solutions for conveying the safety valve are shown below.

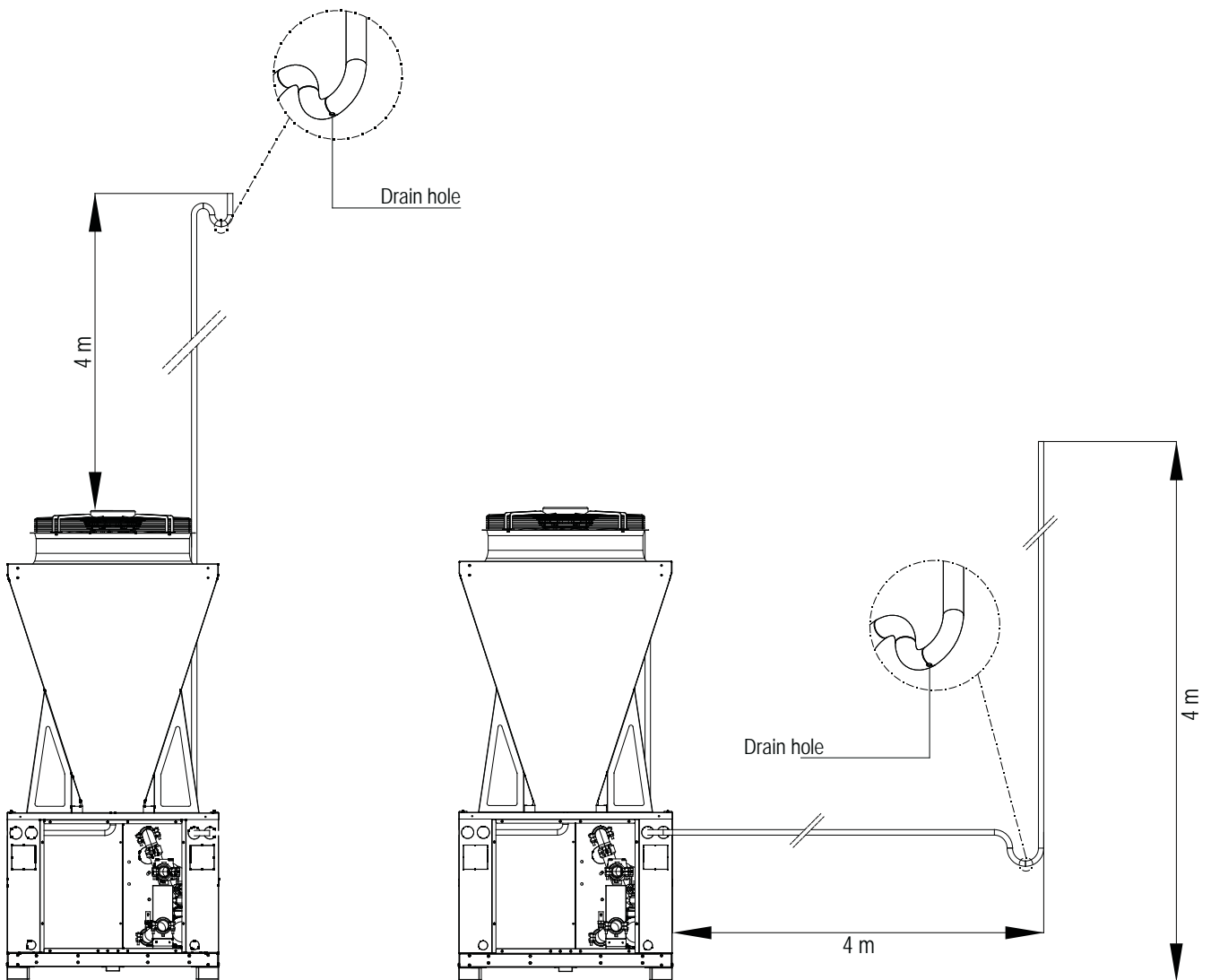

The risk of lightning strikes related to the presence of the metal pipe conveying the discharge of the safety valve can be assessed according to IEC 62305, CEI EN 62305 and other applicable standards if it is deemed appropriate to do so. The analysis must consider, among other factors, the ceramical probability that is typical of the installation site, the conformation of the surroundings and all other elements present near the installation site, such as towers, skyscrapers, bell towers, etc. These elements are often far more relevant than the installation itself in defining the risk of lightning strikes and the consequent actions to limit their effects.

Unless we know what characterises the area, it is not possible to make such an analysis that can be considered effective and correct.

Similarly, the installation of an air-termination unit is usually not necessary and in cases where it is, it must necessarily be carefully dimensioned by the plant designer



The risk of lightning, fire, earthquake, particular snow phenomena, tornadoes and natural events in general cannot in any way be assessed by the manufacturer and are therefore the responsibility of the system designer.

Ice or other natural events must be prevented from obstructing the discharge of the safety valve.

The piping outlet connection must be done so to avoid that rain water, snow, ice, and dirt can accumulate and obstruct the pipeline. The valve discharge must be at a suitable distance from other equipments, systems or ignition sources; the discharged refrigerant must not accidentally enter buildings.

## 5.4 Description of the control panel

### 5.4.1 Position of the control panel

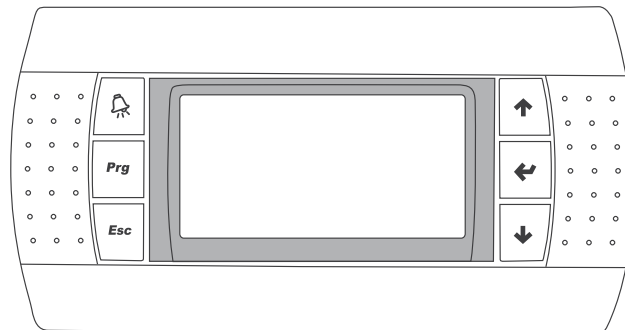





### 5.4.2 Key function

	<b>AL:</b> Access to the alarm menu.
<b>Prg</b>	<b>PRG:</b> Access to the main menu.
<b>Esc</b>	<b>ESC:</b> Go up one level within the menus.
	<b>UP:</b> Scroll up: on the main screen allows to scroll within the quick menus. Within the menu, it allows to scroll through the screens. In edit mode, it allows to change the settings.
	<b>ENTER:</b> On the main screen, it allows access to the quick menus. Inside the menus, it allows to go down one level in the structure and to confirm the choices with the scroll buttons.
	<b>DOWN:</b> Scroll down. On the main screen, it allows to scroll within the quick menus. Within the menu, it allows to scroll through the screens. In edit mode, it allows to change the settings.

## 6. USE

### 6.1 Quick menu

On the main map, scroll with **UP** and **DOWN** to view the following menus:

	ON / OFF: Turn the module on / off
	Info: It allows to view information on the functioning of the module
	Set: Display and modification of the module set points
	Eve: Synoptic of the modular system

### 6.2 ON / OFF Display

In the main screen, scroll with **UP** and **DOWN** and press **ENTER** once the **ON / OFF** icon is displayed 

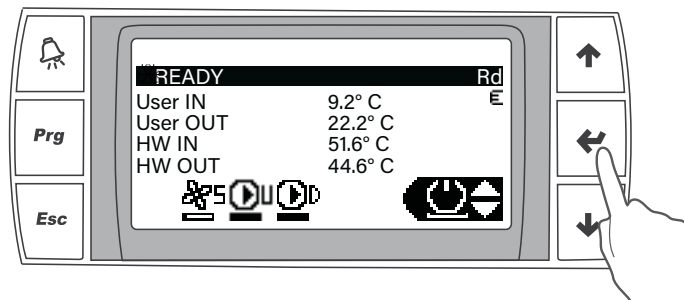

Choose the desired status with **UP** and **DOWN** and press **ENTER** to turn on / off the unit

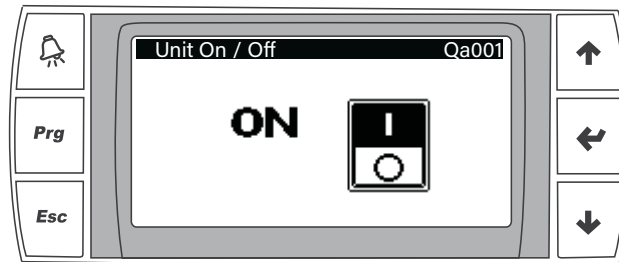

### 6.3 Info menu

In the main screen, scroll with **UP** and **DOWN** and press **ENTER** once the "i" icon is displayed 

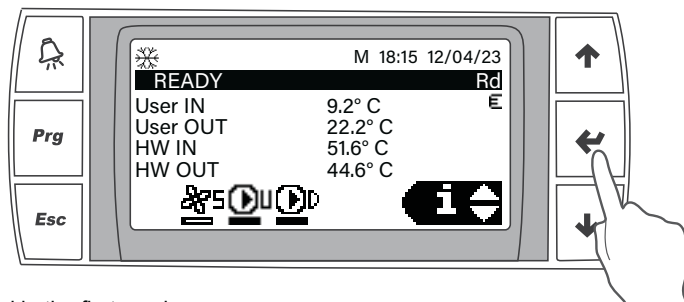

The following variables are displayed in the first mask

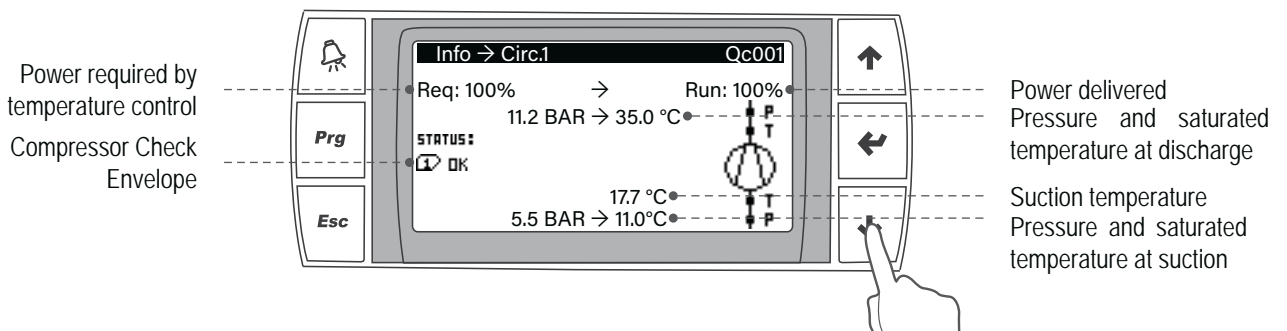



The next screen displays the status of the individual compressors and any counts linked, for example, to the minimum compressor OFF time.

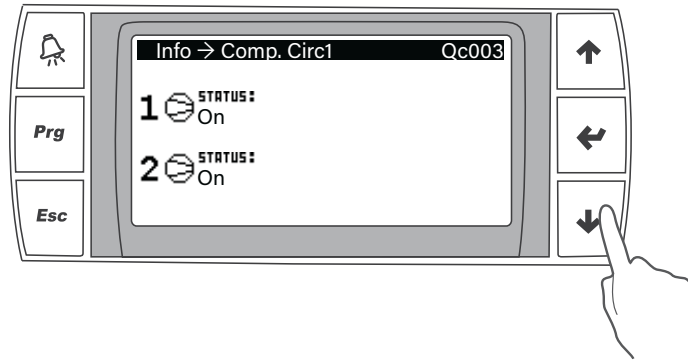

Scrolling further, it is possible to view information relating to the valves such as:

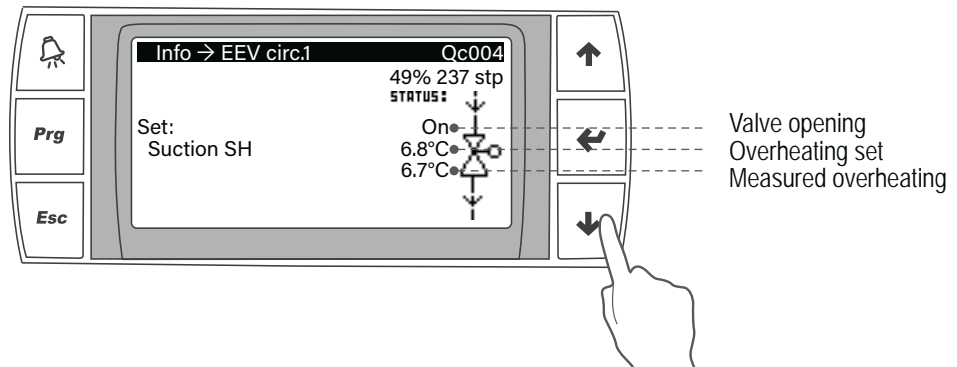

The next screen shows an overview of the external and battery temperatures. Furthermore, other information relating to the unit and its operation is reported.

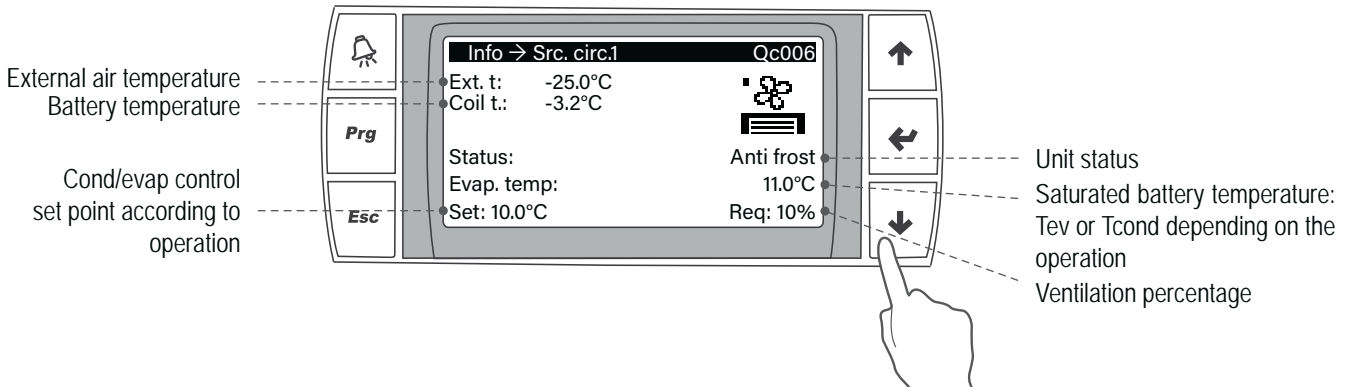

A subsequent screen details the information relating to Defrost

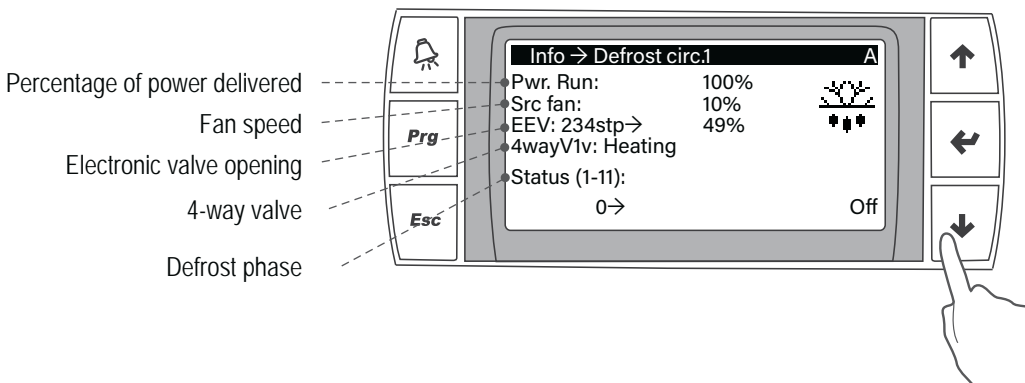

For further details related to the Defrost phases, refer to the Control Manual.

The next screen shows the counts of the defrost times:

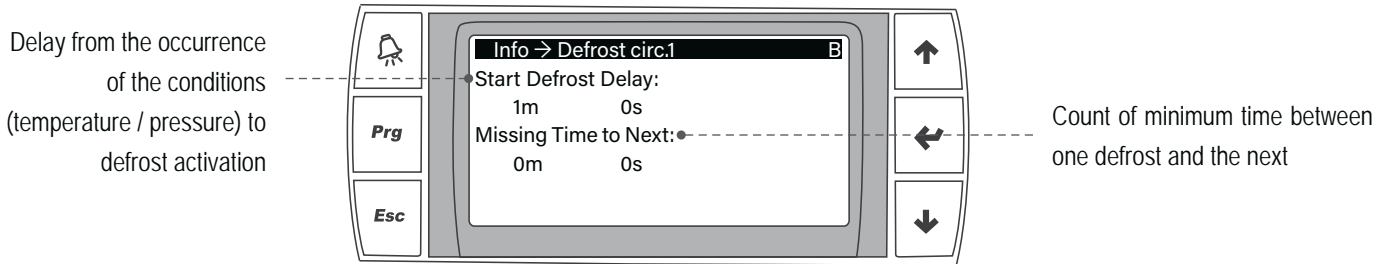

The following screens show in detail the operating conditions of the plant side and recovery side exchangers (in the case of multipurpose units).

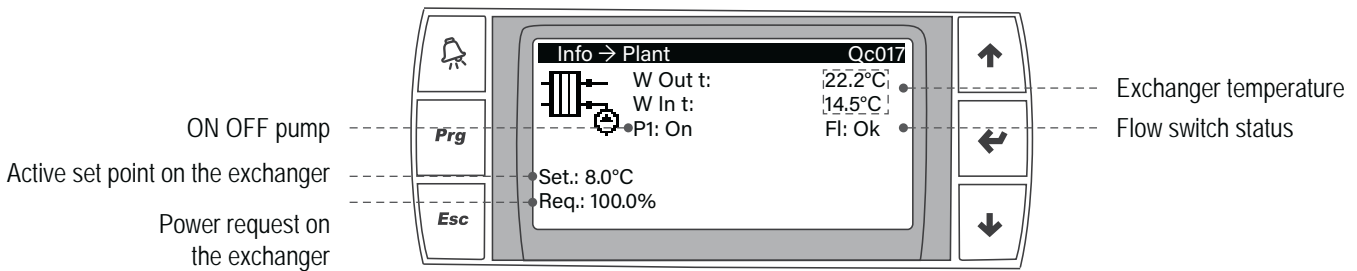

### 6.4 Set point

In the main screen, scroll with UP and DOWN and press ENTER once the SET icon is displayed

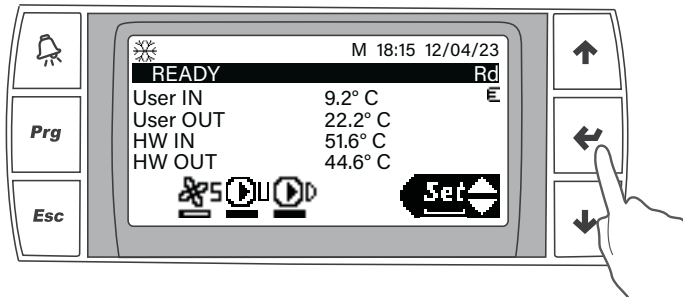

The mask displayed allows to modify the main setpoint.

This setpoint may be different with respect to the active one due to:

- Climatic compensation from external probe
- Activation of second setpoint from Digital Input
- Setpoint activation differentiated by Time Bands

For this reason, the real setpoint actually active on the unit is always displayed below the setting mask.

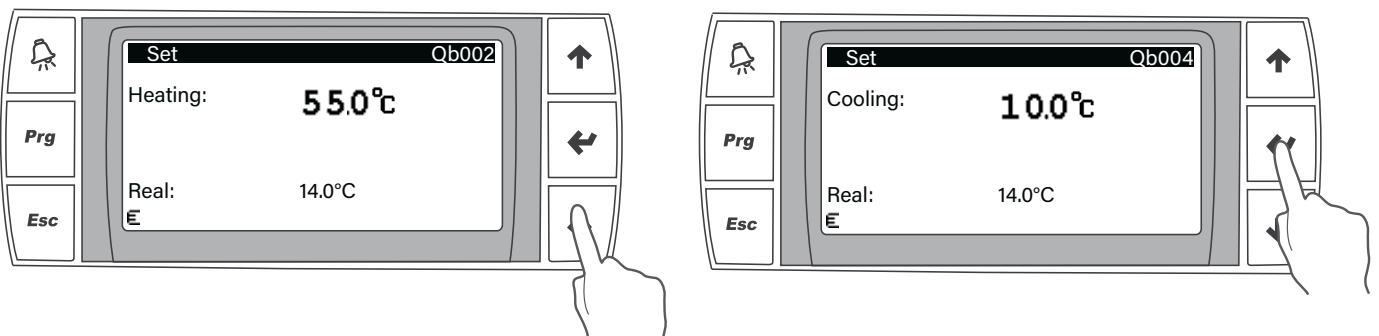

### 6.5 Synoptic of the modular system

In the main screen, scroll with UP and DOWN and press ENTER once the EVE icon is displayed. 

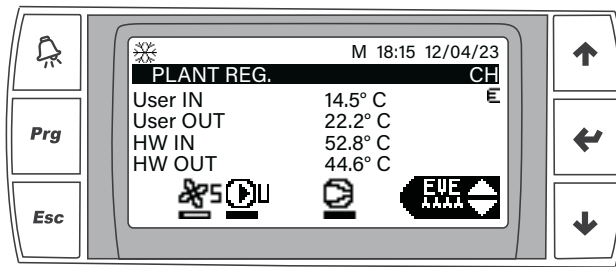

To view the complete the modular system, it is necessary to log in to the Master module. The following mask indicates which unit is being viewed.

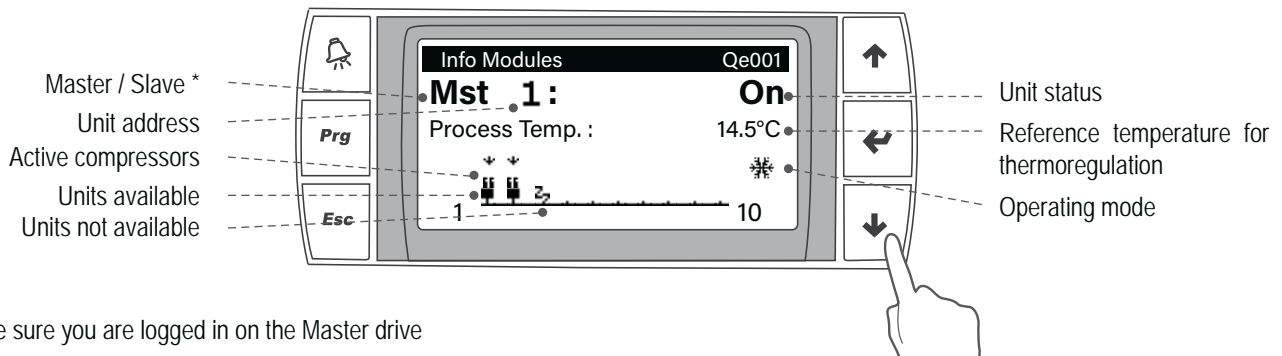





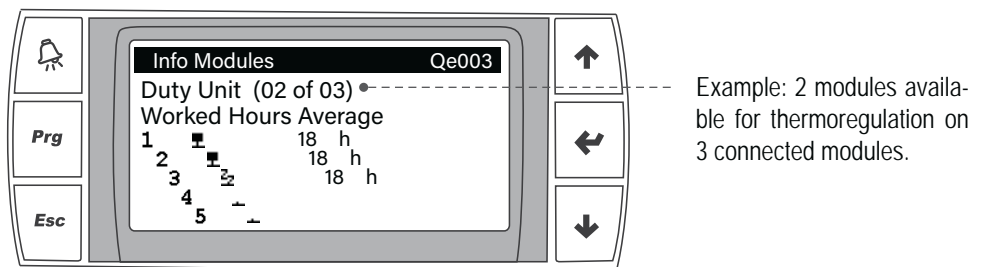







\* Make sure you are logged in on the Master drive

Below, you can view the average operating hours of each compressor on each unit.



#### 6.5.1 Icon legend for module

	Not present		Offline
	On		Initialisation
	Stand-by		Off
	Alarm		Temporarily unavailable for temperature controls
	Source fan		Hot water pump (multi-purpose version)
	User pump		Line = signal indicator

#### 6.5.2 ON / OFF conditions

The unit can be activated / deactivated via the keyboard (as in the previous paragraph) or via the methods described below.

If more than one method is enabled for turning the unit ON OFF, all the conditions must be met for the unit to be ON. If even one of the signals is set to OFF, the unit will remain off.

- **From digital input**

If ON OFF is enabled from the digital input, the unit will be enabled for operation with the contact closed and inhibited (regardless of the ON OFF status from the keyboard, Time Bands, Supervision) if the contact is open.

- **By Time Bands**

The unit can be switched off using Time Bands if the function is enabled. Refer to the appropriate paragraph for this programming.

- **From Serial Communication**

The unit can be switched off via the special register in serial communication.

## 6.6 Access to the main menu

In the main screen, press the **PRG** button to access the menus

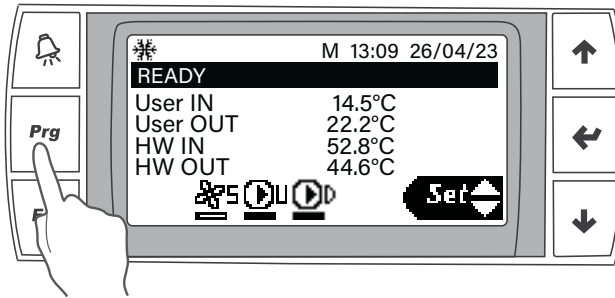

Enter the dedicated password to enable the menus linked to your profile.

To enter the password, scroll with **UP** and **DOWN** and press **ENTER** when the digit is correct to move on to the next one.

User Password is 0001

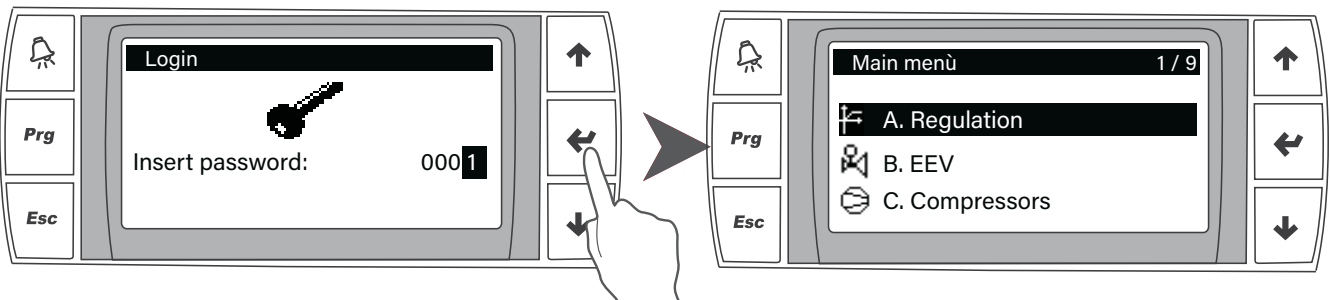

Within the main menu structure (Main menu) it is possible to move with **UP** and **DOWN** and press **ENTER** to enter the submenus and finally modify the parameters; press **ESC** to go back to the upper level of the submenu. This procedure is valid for the entire structure. At the end of the parameter, modification it is necessary to execute the Logout from the appropriate item. Once you have entered the logout submenu, press **ENTER** to confirm the exit.

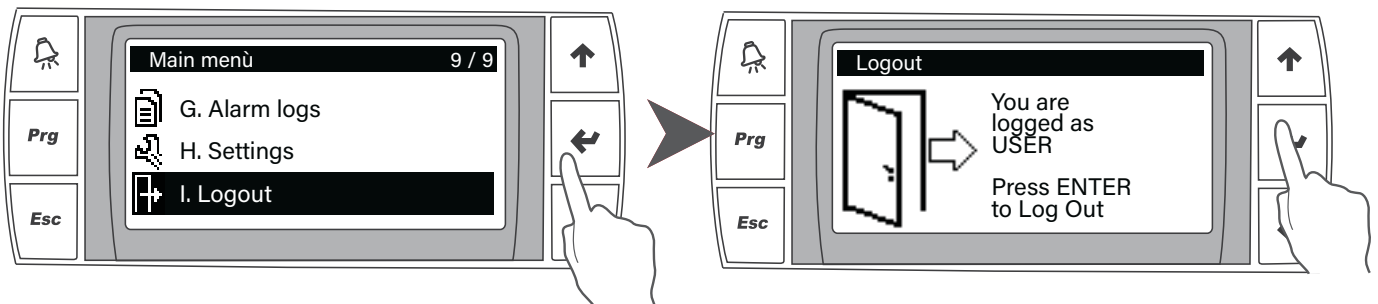

Exceptions:

- If you try to modify a parameter that cannot be accessed at User level, the control will request a higher level password and will prevent the modification by preventing dangerous tampering.

The screens show, at the top left, the indication of the password level required to modify the parameters shown:

M = manufacturer password (Manufacturer password)

S = service password (Service password)

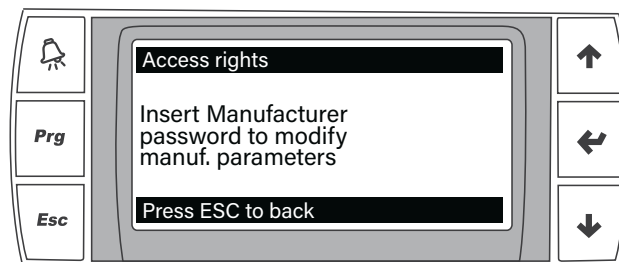

• Depending on the configuration of the unit (carried out at Manufacturer level and modifiable only by the manufacturer) some screens will not be used within the menu. It is possible that the numbering of the masks (top right) is not perfectly sequential.

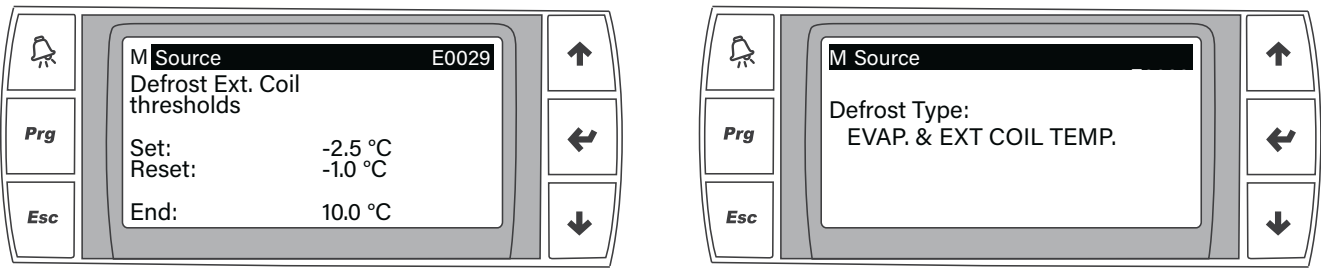

## 6.7 Time bands

### 6.7.1 Time bands settings

The control allows to set up to 4 daily time bands.

If several units are connected, the time bands are set and managed only on the Master.

The time bands can be set from the main menu.

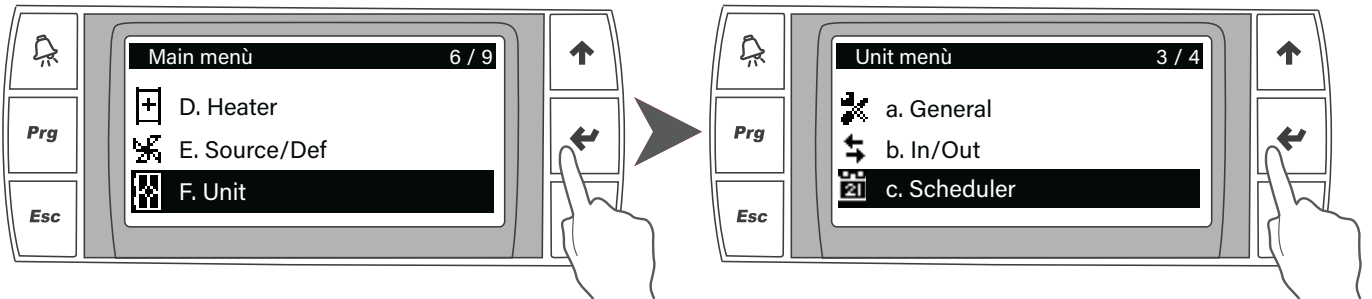

From time bands it is possible to set one of the following operating modes for the unit:

- OFF from time band
- ON with Setpoint Comfort
- ON with Pre-Comfort Setpoint
- ON with Eco Setpoint

The hourly scheduling can be differentiated according to the individual days of the week.

The definition of the 3 different types of set point is detailed in the following paragraph.

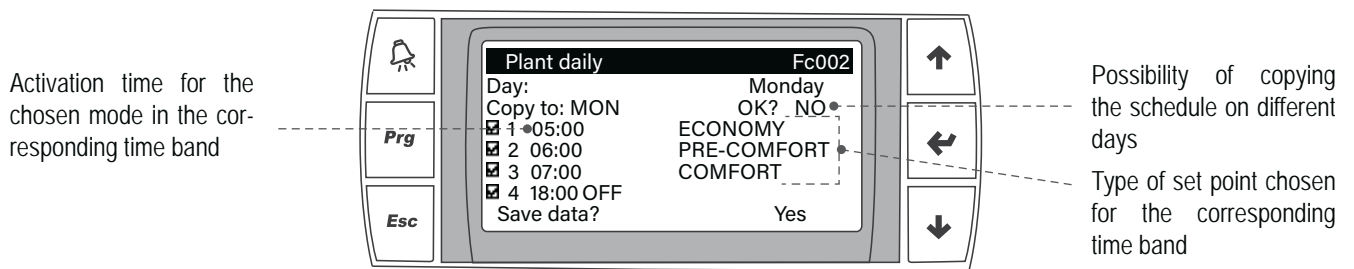

### 6.7.2 Set point from time bands

If the time bands are enabled, it is possible to set 3 different set points by entering the main menu.

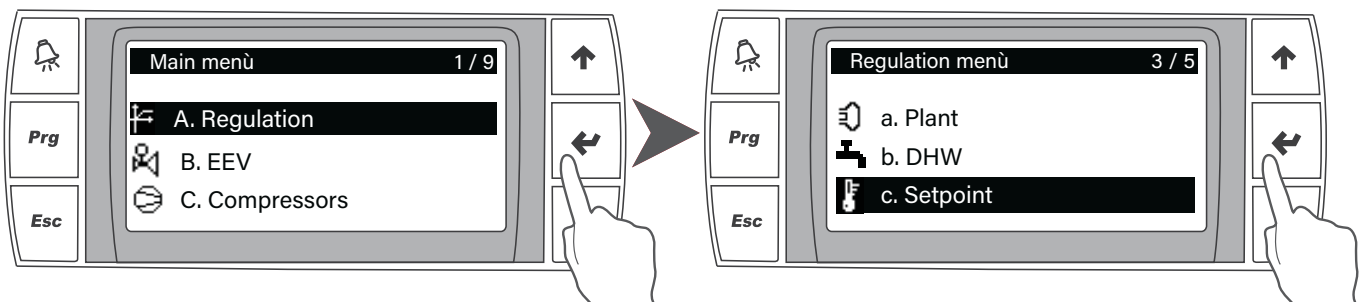

With **UP** and **DOWN** select the set to modify and press **ENTER** to confirm.

Use **UP** and **DOWN** to modify the parameter until the desired value is reached, then press **ENTER** again to confirm.

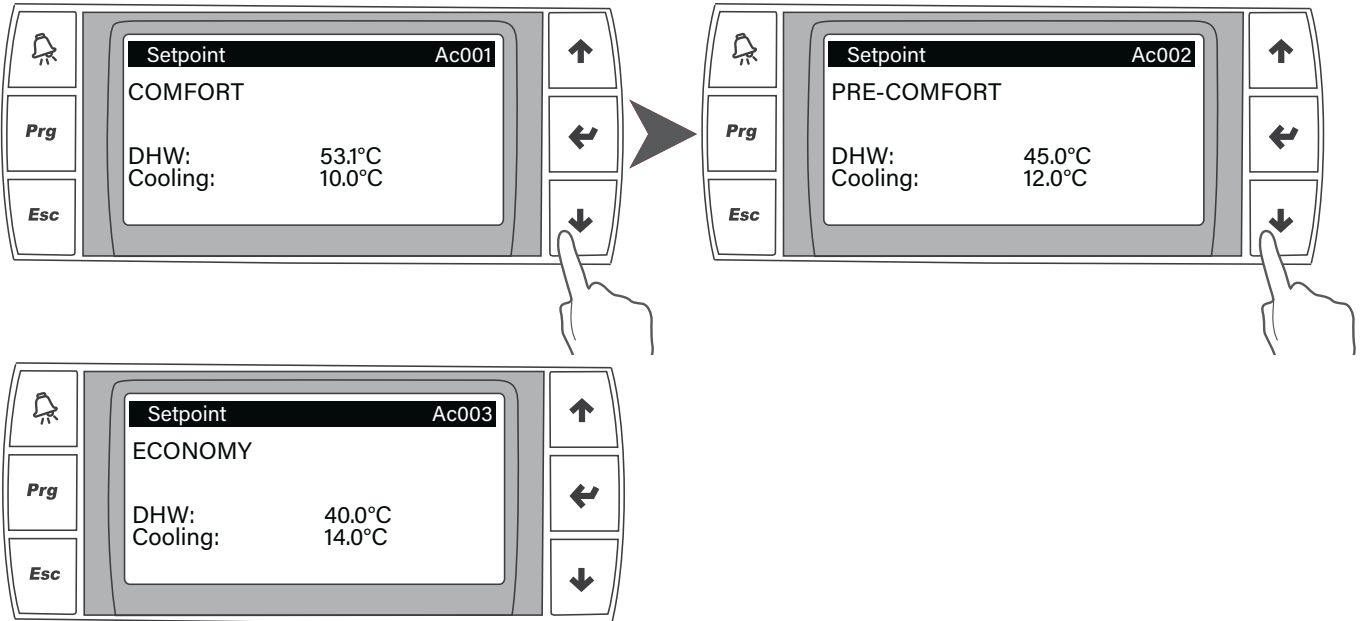

### 6.8 Second Set Point from ID

In the adjustment menu it is possible to set an offset with respect to the main set point on the User side and on the HW side (in the case of multi-purpose units) which can be activated from a digital input.

Press **PRG**, select the "A. Regulation" menu and then "a.plant" and press **ENTER**, scroll with **DOWN** to the desired screen then press **ENTER** to enter the preferences modification mode.

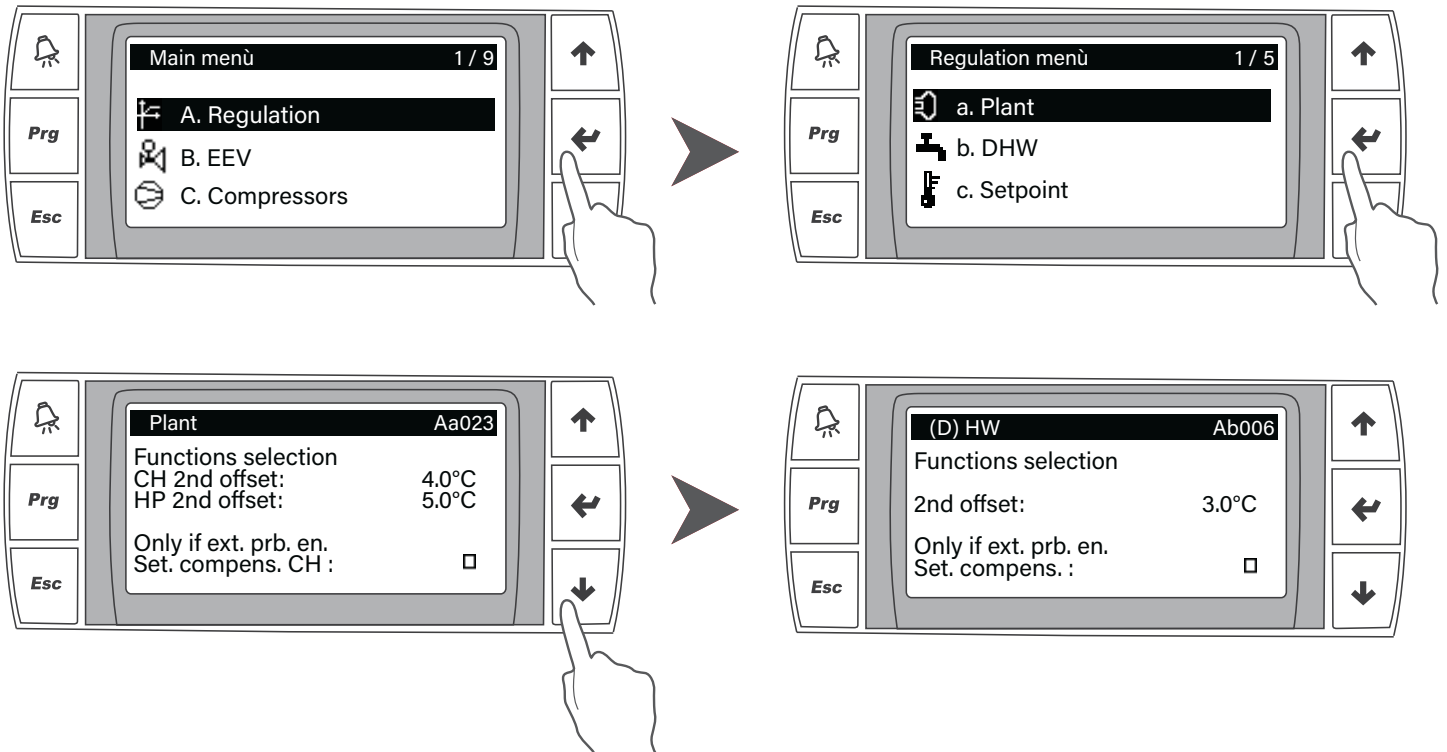

When the digital input is open, the unit operates with the main setpoint, when the digital input is closed the unit applies the set offset to the main setpoint.

Refer to the wiring diagram to identify the digital inputs involved.

## 6.9 I/O

### 6.9.1 General

Access to the Input / Output menu allows to view the current status of the inputs and outputs connected to the command. Press **PRG**, select the "F. Unit" menu and then "b. In/Out" and press **ENTER**; with **DOWN**, scroll through the available screens.

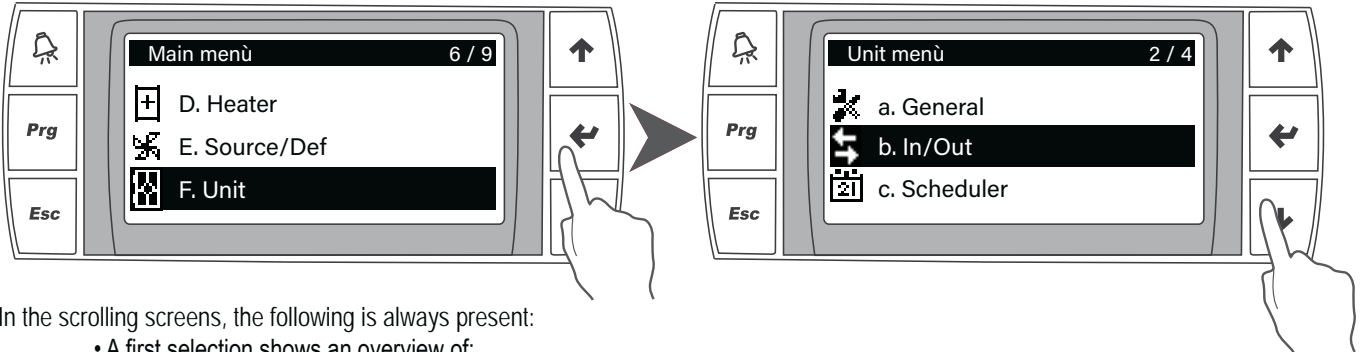

In the scrolling screens, the following is always present:

- A first selection shows an overview of:
  - Digital inputs
  - Digital outputs
  - Analogue inputs
  - Analogue outputs
- The single detail screens relating to the single inputs and outputs with the value and the respective use on the controller.

### 6.9.2 Digital inputs

In the Fb001 screen it is possible to view the individual digital inputs (identifiable on the wiring diagram) and the respective OP (Open) / CL (Close) status.

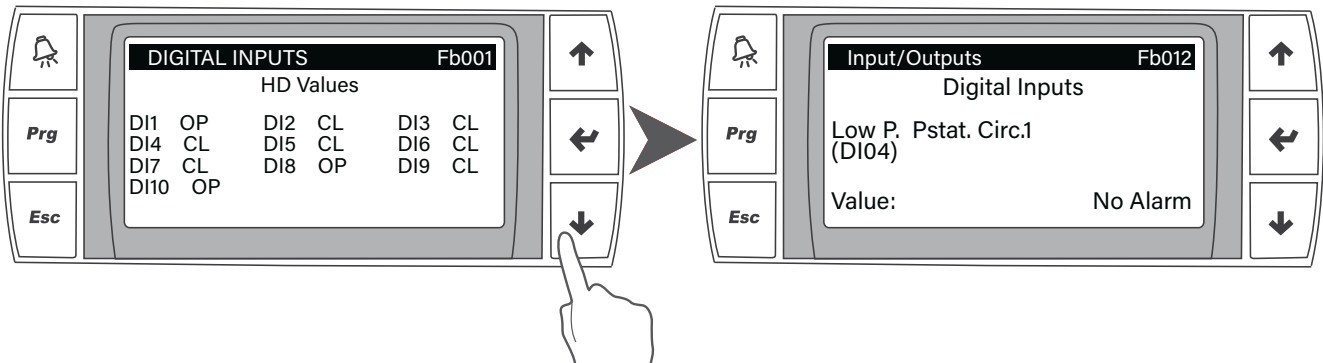

In the following screens, each single digital input is examined and, in addition to the status, the use assigned to it in the control is specified.

### 6.9.3 Digital outputs

In the Fb100 screen, it is possible to have an overview of all the digital outputs and the respective OP (Open) / CL (Close) statuses.

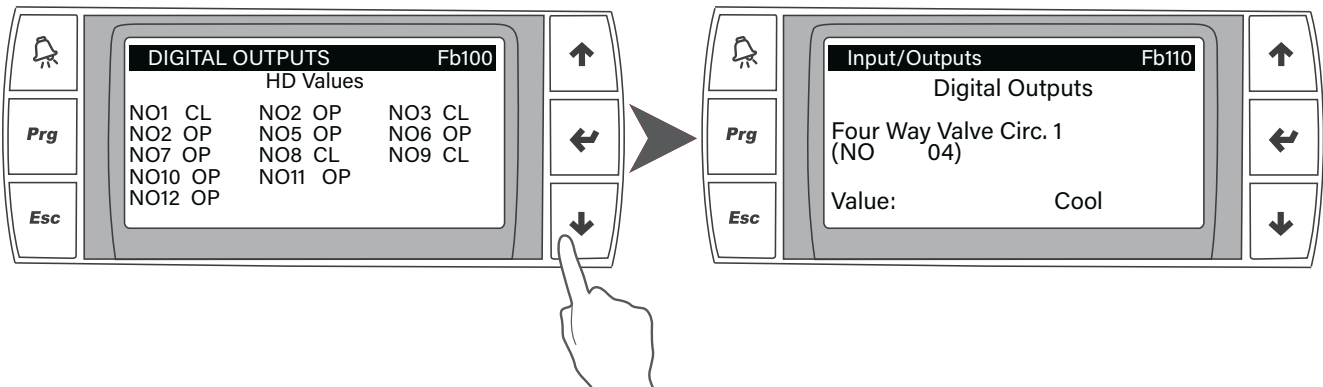

The following screens detail the status and use of each individual digital output.

### 6.9.4 Analogue inputs

In the Fb200 screen, it is possible to have an overview of all the analogue inputs and the respective reading values based on what is connected to them.

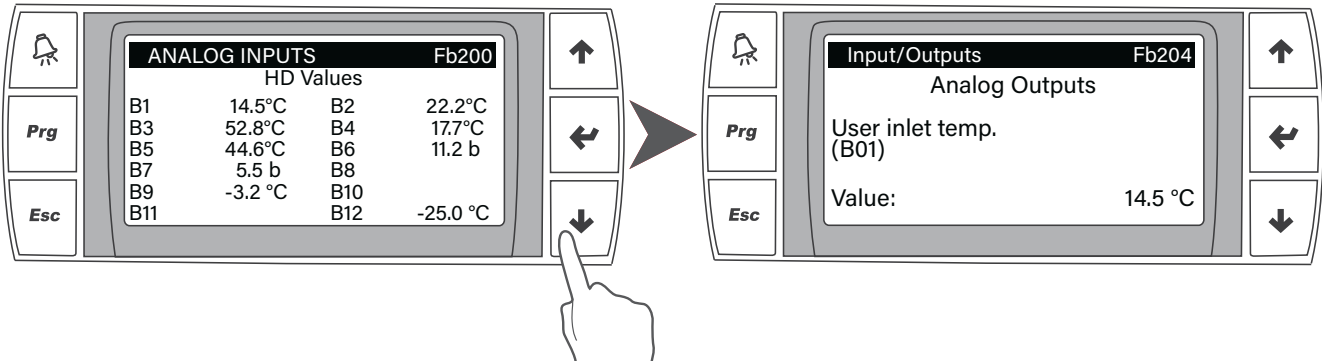

The following screens detail the status and use of each single analogue input.

### 6.9.5 Analogue outputs

In the Fb300 screen, it is possible to have an overview of all the analogue outputs and the respective reading values based on what is connected to them.

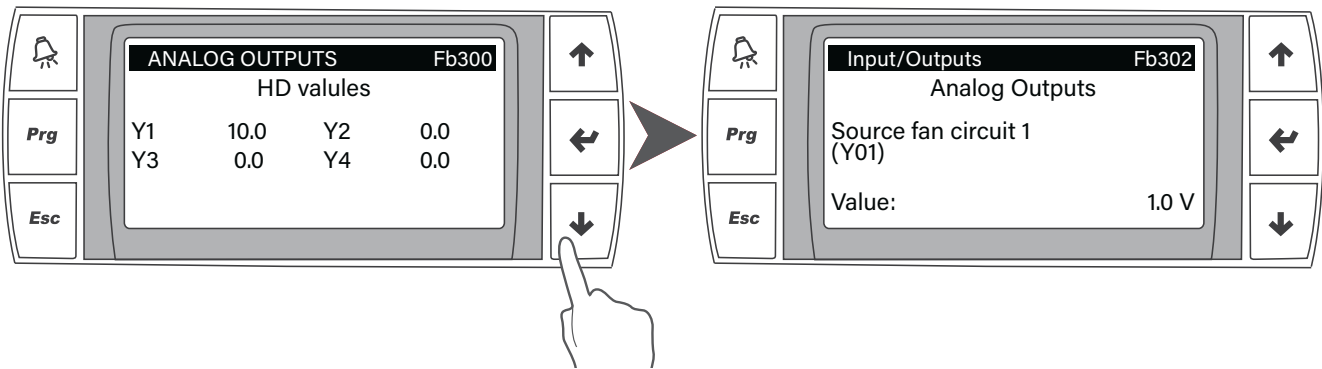

The following screens detail the status and use of each individual analogue output.



## 6.10 Module control functions

### 6.10.1 Intelligent working point control

The system constantly monitors the duty point of the compressor based on the evaporating and condensing pressures.

### 6.10.2 Ventilation

Ventilation is modulated in summer and winter mode in order to minimise energy consumption and allow the compressor to always operate within the working range. The fans will be accelerated to the maximum speed allowed:

- in the chiller with operation at the maximum external temperatures
- in heat pump with operation at minimum external temperatures

### 6.10.3 Valves

The electronic valves are modulated in order to operate a further control with respect to the working point.

In particular, the opening will be increased if the pressure drops excessively (LOP) and the closing if the pressure rises excessively (MOP).

### 6.10.4 Compressors

The control constantly monitors the evaporation and condensing pressures and is able to activate some prevention logics (based on the intervention area) to bring the compressor back to operating within the wrapping:

Possible actions are a combination of one or more of the following:

- slowing down the increase or reduction in power required by delaying the start or stop of a compressor;
- increase in power supplied by hooking up a compressor;
- reduction of the power supplied with the release of a compressor;
- modification of the parameters of the electronic valves in order to induce a variation of the compression ratio

The control algorithm is therefore able to guarantee the correct functioning of the unit even in the most extreme conditions of the work field.

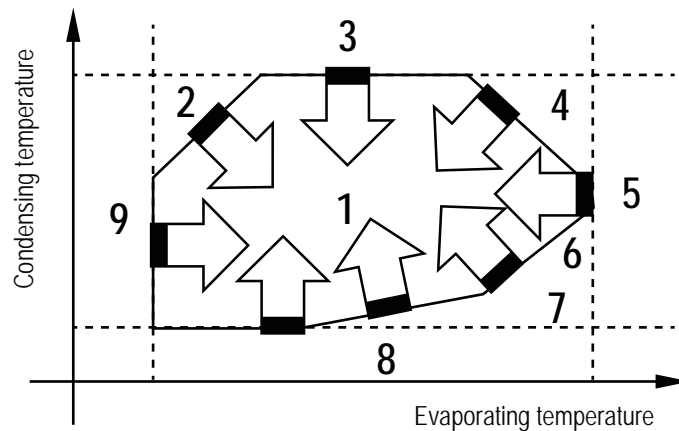

The controller has inside the function of the compressor starting counter. By accessing the masks Ca001 and Ca002 you can read the operating hours and the number of starting of the single compressors.

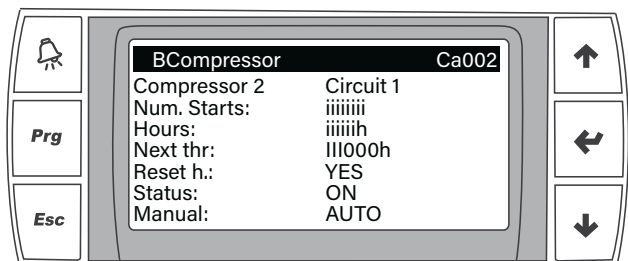
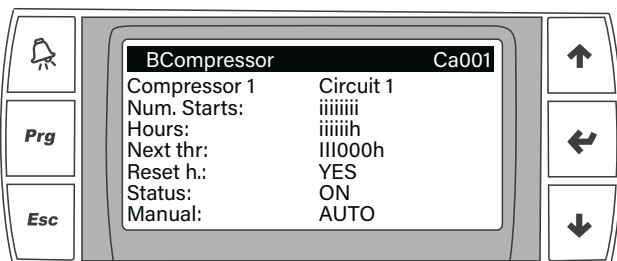

### 6.10.5 Double electronic expansion valve

Each Everest module is equipped with a double electronic expansion valve.

The algorithm integrated in the control is able to predictively choose whether to operate with one or two electronic valves, guaranteeing perfect lamination and control of the refrigerant flow in any working condition and at any thermal load.

### 6.10.6 Advanced defrost logic

The unit is able to detect the coil frosting conditions by combining the working pressures and the temperature detected in strategic positions of the circuit. When the defrost is activated, the single unit switches off the compressors and reverses the cycle by reactivating the compressors to condense on the coil (thawing the fins) and cooling the water on the branch of the system on which hot water was produced (HW in the case of the multi-purpose unit). During defrosting, the fan can be activated for a short time to control the condensing temperature until the fins are completely cleaned. At the end of defrosting there is a dripping phase, with the compressors off, at the end of which a rapid activation of the fans cleans the surface of the fins, preventing the formation of new ice. At the end the compressors are reactivated and the unit returns to operate in the former conditions.

## 6.11 Multi-element control functions

It is possible to connect up to 10 Everest modular units.

These units must be connected mechanically, hydraulically and electronically.

The algorithm implemented inside Everest allows centralised management of the modules in order to maximise the efficiency, stability, reliability and robustness of the system.

### 6.11.1 Initial Configuration

First of all, during start-up it is necessary to connect the units to the intermediate switch via ethernet cables. Refer to the paragraph "Connecting network cables between multiple units." Then, through the display on each single module, the units must be configured in order to make serial communication possible. The LAN must be configured as follows.

Press **PRG** and access the "H.Settings" menu, press **ENTER**, scroll to the "d.Serial ports" menu with **DOWN** then press **ENTER** again to confirm.

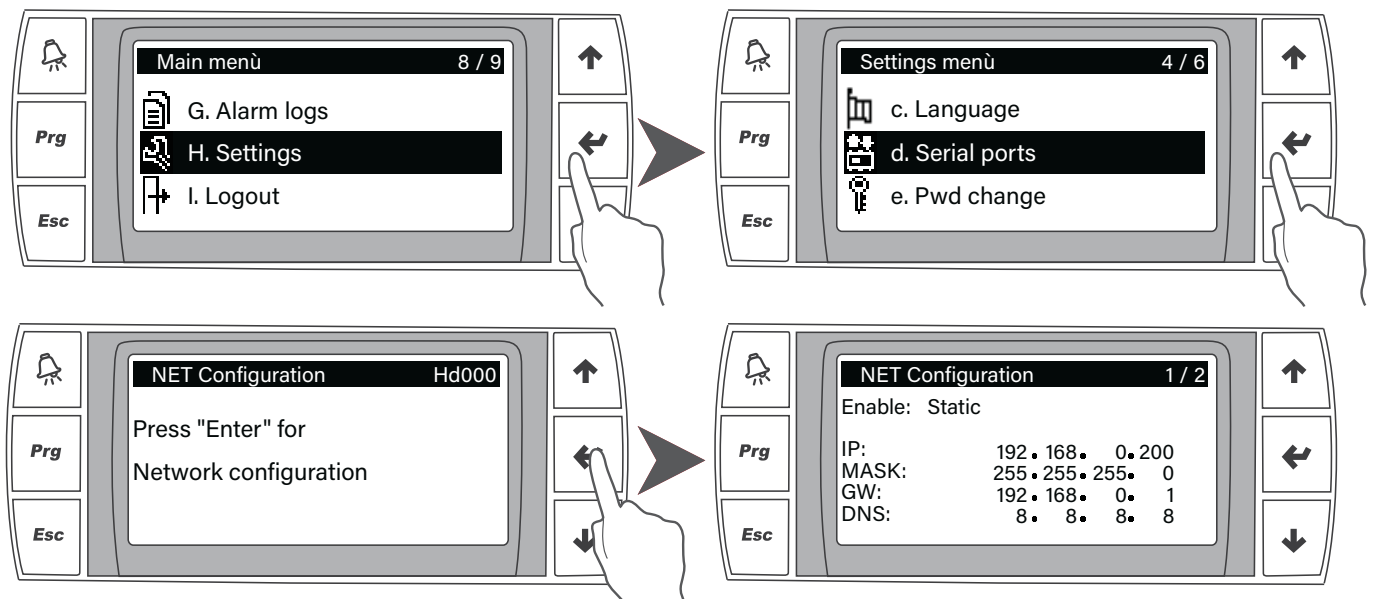

Set static IP making sure the IPs have identical address except the last 3 numbers. Example:

MASTER	SLAVE	SLAVE
Enable: Static <b>IP: 192.168.0.200</b> MASK: 255.255.255.0 GW: 192.168.0.1 DNS: 8.8.8.8	Enable: Static <b>IP: 192.168.0.201</b> MASK: 255.255.255.0 GW: 192.168.0.1 DNS: 8.8.8.8	Enable: Static <b>IP: 192.168.0.202</b> MASK: 255.255.255.0 GW: 192.168.0.1 DNS: 8.8.8.8

The network Master will always be the unit with the lowest IP among those available on the network. If the Master is disconnected from the network, the system is able to react autonomously by assigning the Master function to the next IP among the Everest units connected to the network.



To perform the initial configuration, the unit must have all units turned off but with the controllers powered.



Following a correct configuration of the modular system, the parameters relating to the system regulation must be set on the Master module.



If the KGH or KGR options is included in the Modular System, the fields related to the Net Configuration (Hd000 mask) must be set as in the example. In particular, the IP must be set as 192.168.0.200 on the unit that will assume the role of Master while in the following units the last number must be increased until 192.168.0.209 (in case of a modular system consisting of 10 units).

If two modular systems (A and B) consisting of n and m modules respectively are present at the same site, it will be necessary to give a master to each of the subnets and the IP address setting must be as follows:

Modular system A (n modules)	
IP Master A	192.168.0.200
IP Slave (n)	192.168.0.20(n-1)

Modular system B (m modules)	
IP Master B	192.168.0.20(n)
IP Slave (m)	192.168.0.20(n+m-1)

**Example**

Modular system A (3 modules)	
IP Master A:	192.168.0.200
IP Slave (1):	192.168.0.201
IP Slave (2):	192.168.0.202

Modular system B (4 modules)	
IP Master B:	192.168.0.203
IP Slave (1):	192.168.0.204
IP Slave (2):	192.168.0.205
IP Slave (3):	192.168.0.206

After correctly assigning the IP addresses to all the units present, it is necessary to configure each unit by assigning a progressive number to it and by assigning the IP address of the reference master to each one. To do this, it is necessary to access the menu using password 0123.

Press **PRG** and access the "A.Regulation" menu, press **ENTER**, then press **DOWN** to scroll down to the "e.Elem/StByRot" menu.

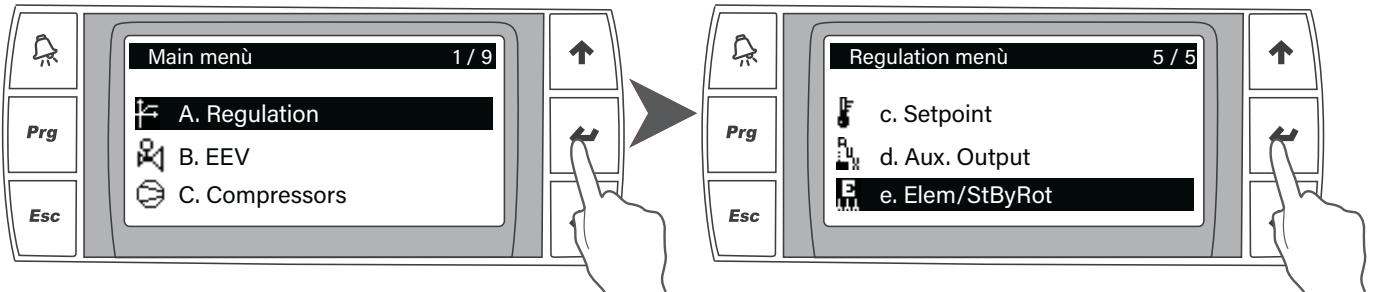

Then press **ENTER** again to access the "Ae001" mask

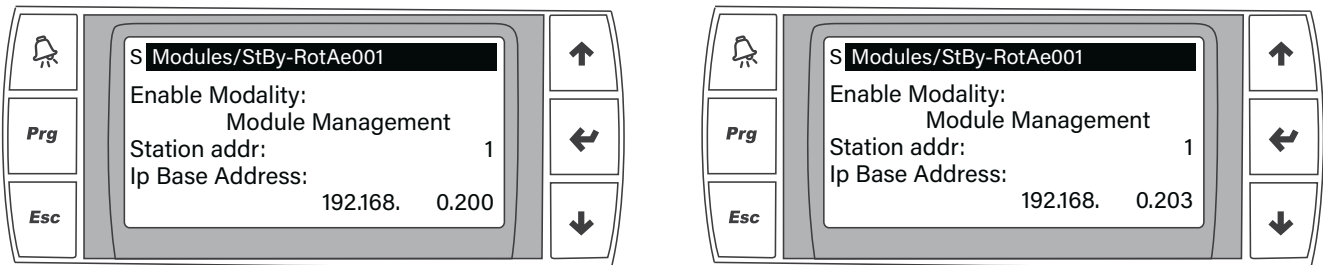

The following parameters must be set in this mask:

- Station addr.: 1 (on the master unit); 2 (on the first slave unit); 3 (on the second slave unit) and so on
- IP Base Address: IP address of the master module of the modular system

Referring to the example already mentioned, the following parameters must be set on each of the modules present:

Modular system A		
Identifier	Station addr.	IP Base Address
Master A	1	192.168.0.200
Slave 1	2	192.168.0.200
Slave 2	3	192.168.0.200

Modular system B		
Identifier	Station addr.	IP Base Address
Master B	1	192.168.0.203
Slave 1	2	192.168.0.203
Slave 2	3	192.168.0.203
Slave 3	4	192.168.0.203

### 6.11.2 "Reserve" modules

In the case of a modular system consisting of 2 or more units, for reasons related for example to the seasonality of the thermal load, it may be useful to leave 1 or more units as a 'reserve' for those in operation. Basically, it is possible to force the master to be able to simultaneously call into operation a smaller number of modules than the total number making up the system, regardless of the required thermal load. The units that are left idle are decided dynamically, again with the aim of balancing the overall hours of operation of the compressors.

The parameter that manages this type of operation can be found in the "Ae004" mask and it is identified with the description "Duty unit".

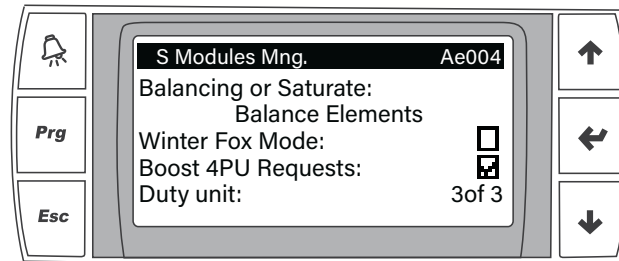

In the example, all the modules making up the modular system can be called into operation if the thermal load requires it. Instead, if 'Duty unit: 2of3' is set, then at most 2 of the 3 modules making up the system can operate simultaneously.

### 6.11.3 Thermoregulation and pump management

The Master module control constantly communicates with the controls of all the other modules (Slaves) available on the network in order to know their status (ON / OFF / Alarm) and the power available for temperature control.

The temperature used for temperature control is defined as follows:

- If all the units are in standby, this is the return temperature of the Master, the only module to keep the pump active without a load request;
- If there is power supply, it is the average of the return temperatures of the units that have been active for a minimum time (to ensure that the reading is significant).

The Master control defines the compressors that must be activated on the basis of the power required by the system, therefore on the difference between the set point and the control temperature.

The activation logic minimises pumping costs by activating high-efficiency pumps only on the modules that require compressor activation. The partialisation of the flow rate is thus much higher than that obtainable with a single inverter pump and, at the same time, optimal operation of the individual units is guaranteed by ensuring the correct flow rate to the plate heat exchanger in all operating conditions.

### 6.11.4 Call priority and balancing or saturation logics

The control is able to implement load distribution logics distinguishing between balancing and saturation.

#### • Balancing

The balancing logic distributes the load among all the units available for temperature control (excluding those kept in standby - see Stabd <>By Rotation logic for selection from the standby rotation logic detailed below).

The call order is defined in order to balance the operating hours of the individual units and will tend to first activate all the units available at partial load, maximising the efficiency of the modular system, and then bring the requested available units to full capacity.

#### • Saturation

The saturation logic brings each single unit to the maximum available power before activating another one.

In this way, on average, (at the same thermal load) a smaller quantity of active modules is maintained, but with a lower overall efficiency.

In the case of multipurpose units, the advanced logic present in the control will distribute the thermal load with a first balancing logic, if set, but through an advanced algorithm it will tend to attribute the additional load in the other operating mode to the same active modules in order to maximise the opportunities of functioning in total recovery.

In this way, it is possible to guarantee a further increase in the efficiency of the modular system, thus being able to choose when to distribute a single load and when to concentrate the request for cold and hot loads to minimise energy consumption.

#### **6.11.5 Standby rotation**

For all applications where the thermal load must be guaranteed even in the event of accidental events, the control allows to define how many modules to make available for thermoregulation and how many to keep in standby, activating them in the event of an alarm from one or more units. In order to ensure correct reactivity and to balance the operating hours of the individual modules, the controller must swap the available units and those in standby, always maintaining the same number of active modules.

#### **6.11.6 Communication failure and unit alarm**

The main control requires continuous communication between the Master module and the individual Slaves.

If one or more units lose communication, the control will reconsider the units actually available by distributing the load among those actually available.

The same occurs in the event of an alarm of one or more units: these units are excluded from the count of modules actually available to support the thermal load and the load is redistributed accordingly; if backup units with standby-rotation logic are available, these units are immediately activated.

In the event that the Master unit loses communication, the Modular System will reassign the role to the unit with the next address, delegating control of the System to it. Continuous updating of the essential regulation parameters ensures that the unit that becomes Master can manage the regulation of the modules without any interruption or variation of service to the system.

## 7. MAINTENANCE OF THE UNIT

### 7.1 General warnings

Maintenance can:

- Keep the equipment operating efficiently
- Prevent failures
- Increase the equipment life



It is advisable to maintain a record book for the unit which details all operations performed on the unit as this will facilitate troubleshooting.



Maintenance must be performed in compliance with all requirements of the previous paragraphs.



Use personal protective equipment required by regulations as compressor casings and discharge pipes are at high temperatures. Coil fins are sharp and present a cutting hazard.



Inside the unit, there can be high voltage zones. Any intervention on them, must be done by authorized personnel qualified in compliance with the local regulations in force.



The surfaces of the components in the compressor discharge side and in the refrigerant liquid line could reach very high temperatures and any contact can cause burns.



Before carrying out any kind of work on the machine, it is necessary to cut off the power supply from the electric panel, by turning the main switch to the OFF position



It is absolutely forbidden to open the refrigerant circuit loaded with refrigerant.



To carry on any intervention requiring the opening of the cooling circuit, follow this procedure:

- 1) activate the crankcase heater of the compressor for 4 hours minimum-
- 2) recover the refrigerant by means of an approved cylinder
- 3) make the vacuum in the circuit
- 4) flow the circuit with inert gas (nitrogen)
- 5) use orbital blades to dissect the pipes



Smoking is forbidden during maintenance operations.

## 7.2 Drive access

Access to the unit once installed, should only be possible to authorized operators and technicians. The owner of the equipment is the company legal representative, entity or person owns the property where the machine is installed.

They are fully responsible for all safety rules given in this manual and regulations. If it is not possible to prevent access to the machine by outsiders, a fenced area around the machine at least 1.5 meters away from external surfaces in which operators and technicians only can operate, must be provided.

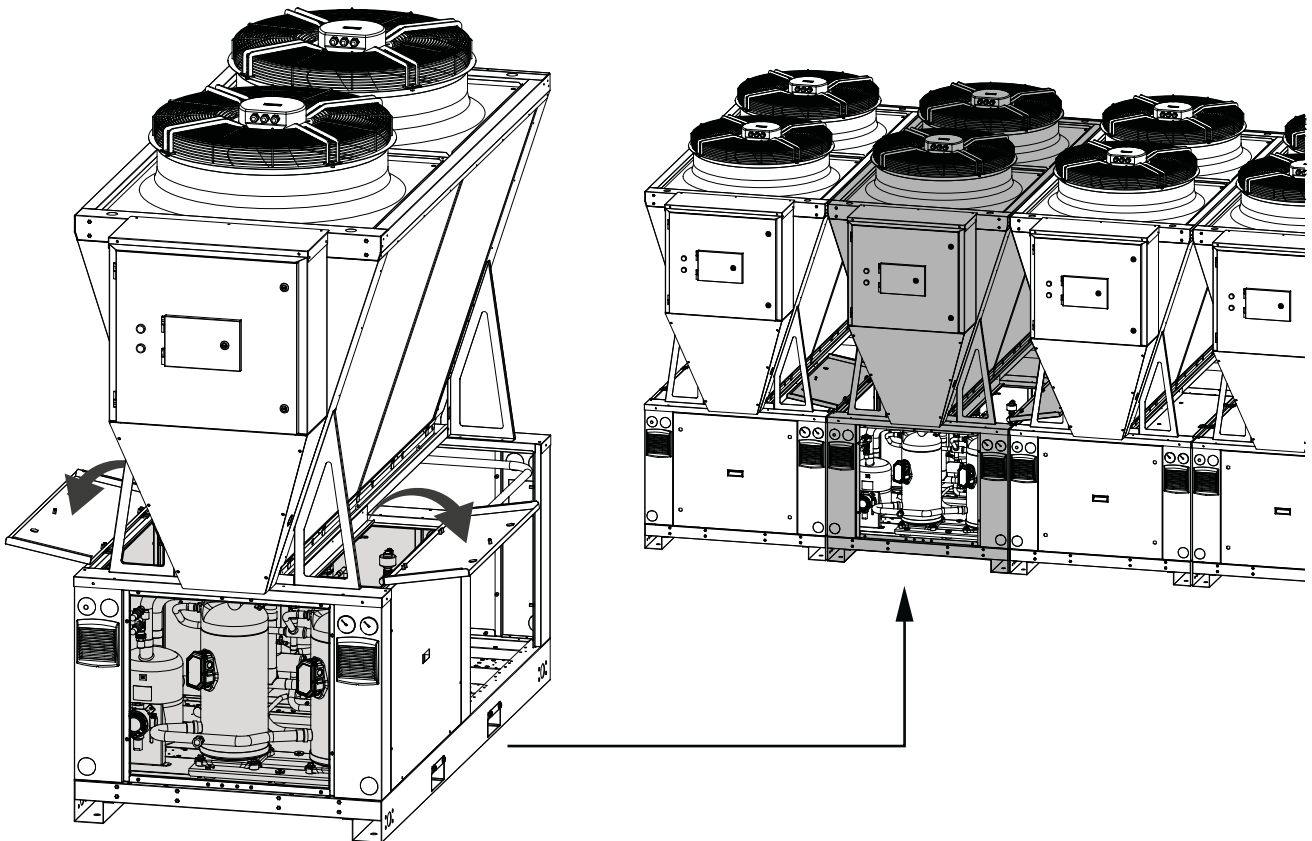

All the main components are accessible from the front for maintenance, both for the single unit and in a modular configuration.



To facilitate checks on valves, coils, lights, connectors, etc., it is possible to open the panels of the technical compartment at the top if the intervention cannot be performed by removing the front panel alone.



### 7.3 Routine maintenance

The Owner must take care that the unit is adequately maintained, according to the indications contained in the Handbook and what required by current local laws and regulations.

The Owner must take care that the unit is periodically suitably inspected and maintained, according to the system type, size, age and functions and to the indication in the Handbook.



If leak detection instruments are installed on the system, they must be inspected at least once a year, to check that they work properly.

During its operation life the unit must be inspected and checked as stated by the current local laws and regulation. In particular, unless more restrictive specifications, follow the recommendation on the following table (see. EN 378-4. encl. D).

CASE	Sight Inspection (par. 4.2, p.ti a - l)	Pressure test	Leak detection
A	X	X	X
B	X	X	X
C	X		X
D	X		X

A	Inspection, after an intervention, with possible effects on the mechanical resistance or after a change of purpose or after a stop longer than 2 years; all unfit components must be replaced. Do not carry on checks with higher pressures than design ones.
B	Inspection following an intervention, or a relevant modification of the system or its components. The check can be restricted to the components involved in the intervention, but if a refrigerant leak is detected, a leak detection must be made on the all system.
C	Inspection following a change of the unit position. If there is the chance to have effects on the mechanical resistance, refer to point A.
D	Refrigerant leak detection after a justified suspicious. The system must be checked to find any leaks, using direct measures (devices able to find the leak) or indirect ones (deduction of the leak presence analysing the operational parameters), focusing attention on those parts which are more easily exposed to leaks (junctions, for example).



If it is detected a fault that endangers the reliable operation of the unit, it's necessary to rectified it before restart the unit.

### 7.4 Exceptional Maintenance

#### 7.4.1 Procedure for Vacuum break and Refrigerant Charging



Charging R290 refrigerant is a very difficult operation. If it is not carried out in the correct way, it can cause serious damage to the compressor due to the high miscibility of the oil in the refrigerant, which can lead to the compressor operating without lubricant in the case of large amounts of liquid in the receiver. After the vacuum has been applied to the circuit, the correct procedure consists of the following steps.

1. Vacuum break
  - a. Insert the minimum freon charge at the circuit required to carry out the leak test. Do this by inserting a small charge of refrigerant and allow it to evaporate until the pressure gauge is stable; repeat the procedure until a stable value of at least 2 bar is reached.
  - b. until a stable value of at least 2 bar is reached.
  - c. Proceed to the inspection for any leaks.
2. Control and driver configuration (if required)
  - a. Once the programming has been done, close the electronic thermostatic valves and ensure that the closure is leakproof by the appropriate magnet.



The thermostatic valve closes after driver configuration; if it is only powered, it does not close.

c. Set the unit to summer mode/cold water production (for multifunction units and/or heat pumps).

3. Refrigerant charge

- a. Ensure that the crankcase heater has been switched on for at least 12 hours before starting the charging operation and that the electronic thermostic valves are always closed with the appropriate magnet.
- b. When the compressor is switched off, introduce the minimum charge of refrigerant required for the initial start-up ( to avoid activating the low pressure switch). Never charge more than 1/3 of the charge indicated on the plate at this step; apply the charge on the coil liquid line.
- c. Slowly charge the refrigerant above the evaporator until the thermostatic valve begins to operate.
- d. Check and complete the refrigerant charge with the unit fully operating at nominal conditions.

7.4.2 Extraction of a unit from the modular system

The needs to remove a unit from the modular system, for maintenance or other purposes, do not affect the operation of the system while waiting for the removed unit to be repaired or replaced. To remove the unit, it is necessary to operate as follows:

- Secure the hydraulic part by closing the valves on the delivery and return pipes;
- Remove the Victaulic joints that connect the hydraulic pipes inside the unit to the delivery and return manifolds;
- Open the circuit breaker and disconnect the power supply;
- Disconnect the data and signal transmission cable;

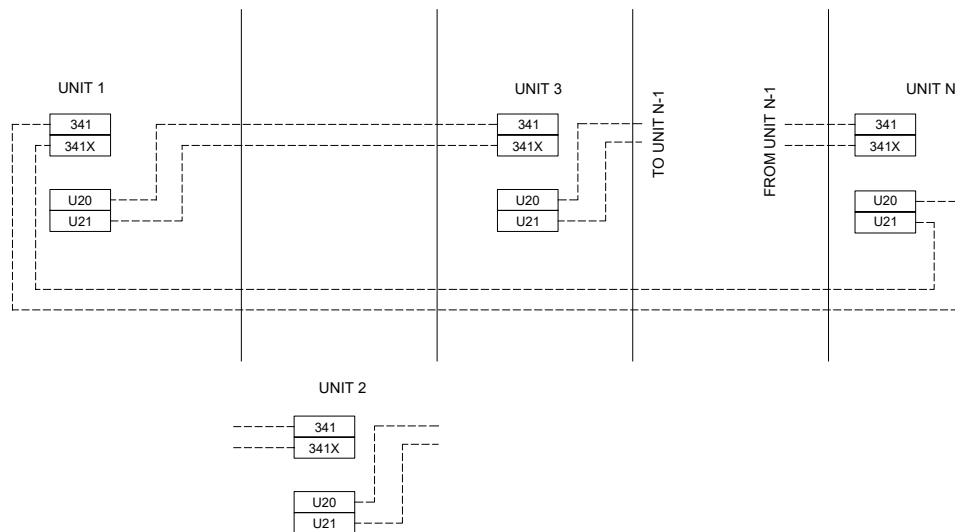

- Move the KG5/KG10 kit (if present) following the instructions in the dedicated paragraph "Mains cable connection between several units".
- Disconnect the electrical wiring on inputs 341-341X and outputs U20-U21 and reset them bypassing the unit to be removed as shown in the following diagram.
- Remove the anchor plates joining adjacent units on the upper and lower edges on the front and rear side;
- Remove the ground anchorage system.

Subsequently it is possible to lift and remove the unit by forklift truck.



Near the open switch, clearly indicate by means of a very visible sign not to close it due to maintenance activities being in progress.

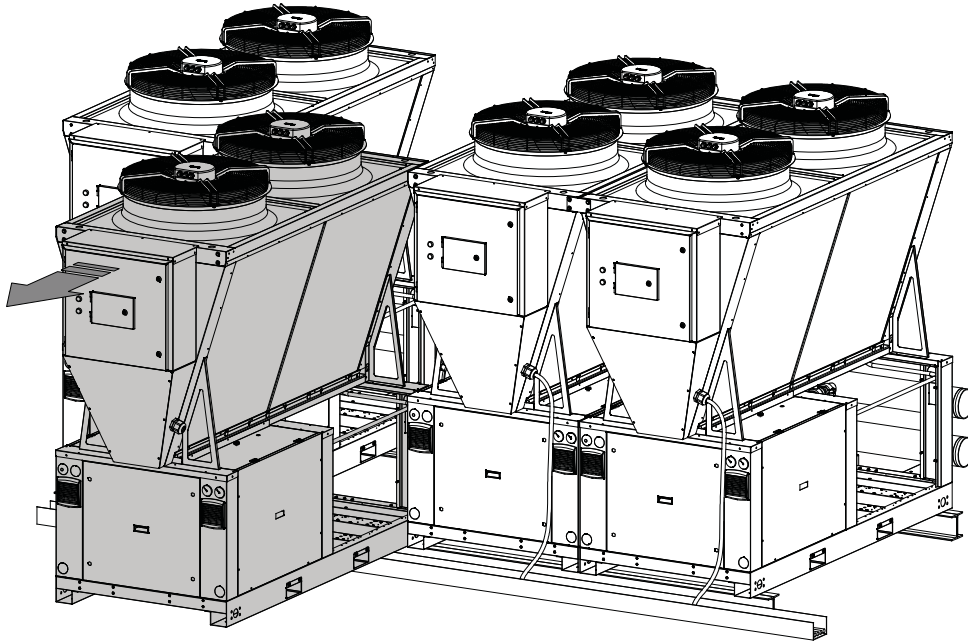

In order to lift and extract the module from the system, it is necessary to handle it from the front using forks at least as long as the module itself.

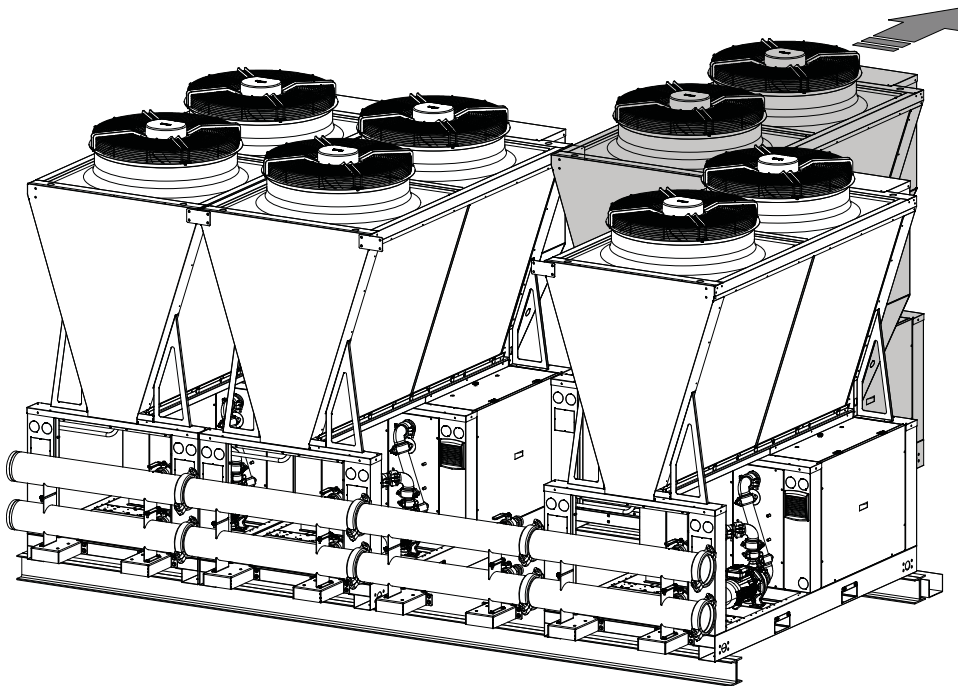

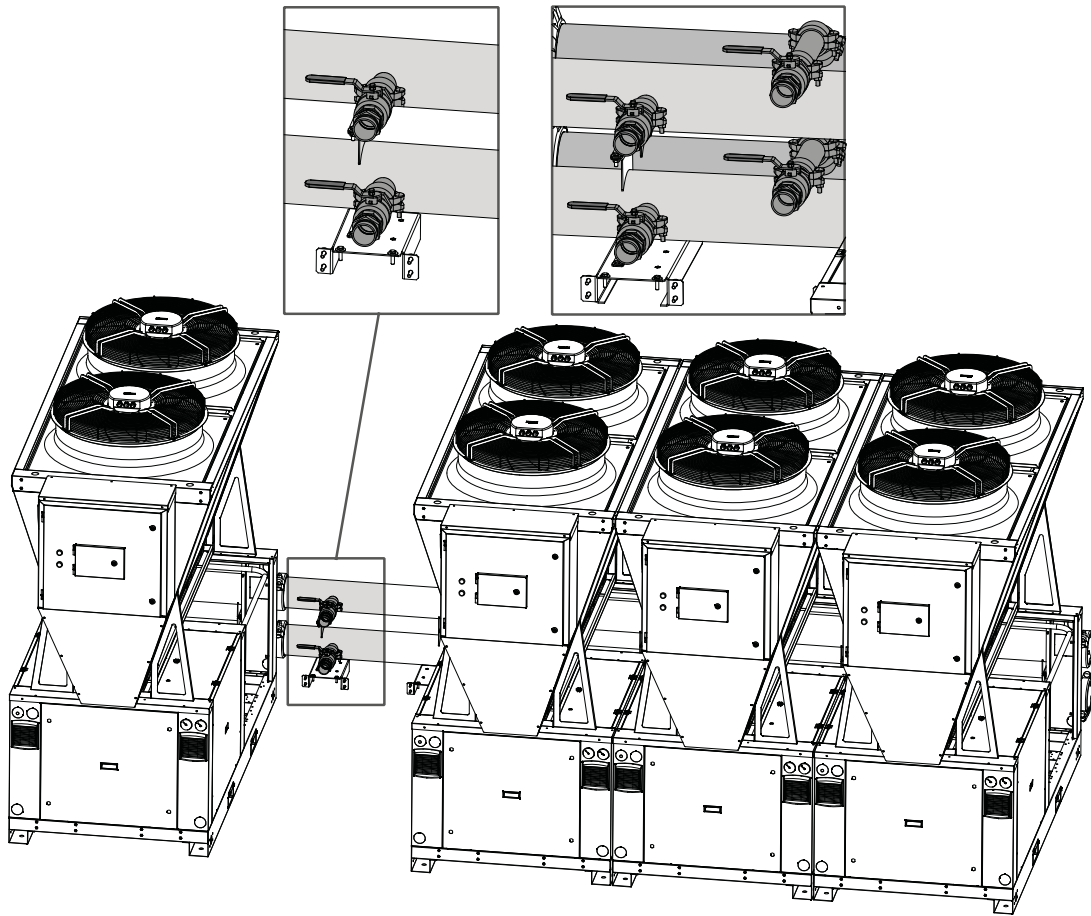

Make sure that the valves on the delivery and return manifolds are closed before removing the Victaulic joints present.

## 7.5 Periodical checks



The start-up operations should be performed in compliance with all requirements of the previous paragraphs.



All of the operations described in this chapter **MUST BE PERFORMED BY TRAINED PERSONNEL ONLY**. Before commencing service work on the unit ensure that the electric supply is disconnected. The top case and discharge line of compressor are usually at high temperature. Care must be taken when working in their surroundings. Aluminium coil fins are very sharp and can cause serious wounds. Care must be taken when working in their surroundings. After servicing, replace the cover panels, fixing them with locking screws.

### 7.5.1 Electrical system and control devices

Actions	Frequency						
	Daily	Monthly	Every 2 months	Every 6 months	Once a year	Every 5 years	If required
Check that the unit works properly and that there are no alarms	X						
Visually inspect the unit		X					
Check unit noise and vibration		X					
Check safety devices and interlocks				X			
Check the unit performances				X			
Check the absorbed current of the components (compressors, fans, pumps, etc.)				X			
Check the supply voltage of the unit				X			
Check the connection of cables to the pre-arranged clamps				X			
Check the integrity of the insulating coating of the electrical cables					X		
Check contactors conditions and functioning					X		
Check microprocessor and display functioning			X				
Check microprocessor set parameter values					X		
Eliminate any dust from electrical and electronic components				X			
Check probes and transducers functioning and calibration					X		
Check evaporator refrigerant level sensor functioning (if present)					X		
Check evaporator refrigerant level sensor calibration (if present)					X		
Perform the calibration procedure or the refrigerant leak sensor functional test (*)					X		
Check the state and function of the voltage-free contact "leakage alarm" identified with "U20-U21" in the terminals					X		

(\*) Follow the section in the manual

### 7.5.2 Condensing coils fans and cooling circuit

Actions	Frequency						
	Daily	Monthly	Every 2 months	Every 6 months	Once a year	Every 5 years	If required
Visually inspect condensing coil		X					
Clean finned coils <sup>(1)</sup>				X			
Check the water flow and/or any leaks		X					
Check that the flow switch is working properly				X			
Clean the metallic filter on the water pipe <sup>(2)</sup>				X			
Check fans noise and vibration		X					
Check fans supply voltage				X			
Check fans electrical connection					X		
Check proper operation and calibration of the fans speed regulation system					X		
Check 4 way valve proper operation (if present)					X		
Check 3 way valve proper operation (if present)					X		
Check presence of air the hydraulic circuit		X					
Check the color of the humidity display on the liquid line				X			
Check if there are any freon leaks							X
Check the operation of the technical compartment ATEX emergency fans <sup>(3)</sup>					X		



<sup>(1)</sup> If the unit is installed in strongly windy areas, near coasts or deserts or in areas subjects to wind and/or sand storms, or near airports, industries or in places with high levels of air pollution in general inspect the unit more frequently (**every three months**) to check the real condition of the surface protection. follow the instructions given in the paragraph "Cleaning the microchannel condensing coils".



<sup>(2)</sup> It can be carried out with a higher frequency (also weekly) depending on the Δt.



<sup>(3)</sup> It's recommended to replace them every 5 years

### 7.5.3 Compressor

Actions	Frequency						
	Daily	Monthly	Every 2 months	Every 6 months	Once a year	Every 5 years	If required
Visually inspect compressors		X					
Check compressor noise and vibration		X					
Check compressors supply voltage				X			
Check the compressors electrical connections					X		
Check the oil level in the compressors using the oil level indicator light.				X			
Check that the crankcase heaters are powered and working properly.		X					
Check the conditions of the compressors electrical cables and their connection to their clamps				X			



Monthly and daily procedure can be directly done by the Owner. The other interventions must be done by qualified and suitably trained personnel.



Do not start any cleaning operation before disconnecting the unit from the electrical power supply, turning the main switch to OFF Position. Do not touch the equipment with barefoot or wet /damp parts of the body.



Any intervention on the cooling circuit must be done by qualified and suitable trained technicians, licensed in compliance with current local laws and regulation.

#### 7.5.4 Periodic checks of the refrigerant gas detection sensor

It is mandatory to subject the refrigerant gas detection sensor to regular visual and functional checks in order to make sure that it is working properly and to guarantee a compliant level of safety. These checks must be performed by properly trained and qualified personnel, according to the procedures and frequencies described below.

##### Visual check

The visual check must be performed at least every 6 months and even more frequently if the environmental conditions in which the unit operates require it.

The purpose of the visual check is mainly to verify that:

- The sensor head is free of dust, dirt or any other residues
- The electrical wiring is intact and in accordance with the documentation accompanying the unit

##### Functional check

The functional check must be performed annually and in any case within the maximum limit of 400 total days passed with the sensor powered.



If the functional check of the sensor is not performed within the total 400 days, the unit will go into lockout and the following message will appear on the display: "Check sniffer alarm" and it can only be operated again after performing the functional check, with positive outcome, according to the procedure described.

To perform the functional check, it is necessary to have the special sample cylinder calibrated to deliver 500ml/min of a mixture containing 0.85% Propane in air (50% LFL) following the procedure described (to be read carefully before starting the operation).

1. Screw the flow meter (1) onto the cylinder and connect the clear tube between the cylinder and the adapter (2). Then screw the adapter onto the sensor head (3)

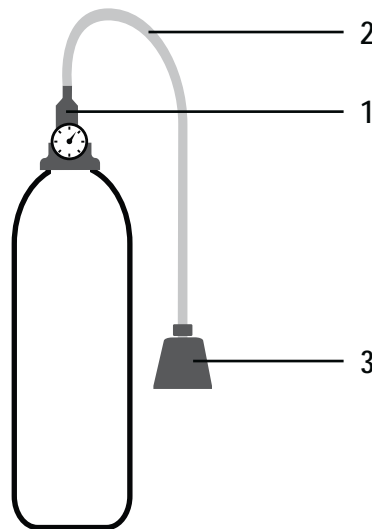

2. With the unit powered and operational, press the blue button located on the external part of the electrical panel
3. The unit will switch OFF and enter the "Check sniffer alarm" mode, which can be seen on the display, and it will remain in this condition for the next 10 minutes
4. Start dispensing 500ml/min of refrigerant and make sure that within the next 70 seconds the sensor goes into alarm because the maximum threshold has been exceeded (manual sensor reset) (\*)
5. The ATEX emergency fans and the light alarms located on the electrical panel must be active
6. Remove the adapter previously screwed onto the sensor head and wait 5 minutes to allow the ventilation system to disperse any traces of refrigerant
7. Then reset the sensor by acting on the unit's main switch (power OFF/ON)
8. The sensor will carry out the self-calibration procedure and, if this is successful, the unit will return to the ON operating state
9. On the display, go to the dedicated screen and reset the counter, which will restart from 0 (\*\*)
10. Reset the check sniffer alarm by pressing and holding the alarm button on the display for a few seconds



(\*) If the alarm is not activated within 70 seconds from when the dispensing started, then it is necessary to replace the head.

(\*\*) CAREL interface to be accessed to reset the hour meter (Hf007)

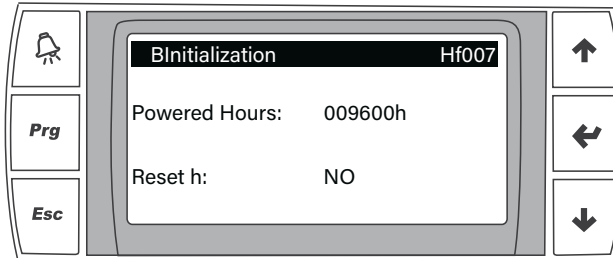

Any periodic check and/or maintenance operation on the sensor must be reported in a logbook indicating the date the check was performed, the name of the technician who performed the check, any anomalies found and the response times detected during the functional test.

In any case refer to the handbook of the detector supplied with the unit.

### 7.5.6 End of seasons

If the unit is to be left out of commission for a long period, the hydraulic circuit should be drained down. This operation is compulsory if the ambient temperature is expected to drop below the freezing point of the fluid in the circuit (typical seasonal operation). Before a new filling, the system must be washed.



After a long period of inactivity, before restarting the unit please keep the crankcase heaters energized for at least 12 hours.



### 7.5.7 Unit OFF

To stop the unit, press the ON/OFF key on the microprocessor, turning it on OFF position. If the unit will be OFF for more than 24 h turn the main switch to OFF position to cut the unit electrical power.

If any malfunction has occurred during the unit operation, solve it asap, in order to avoid that it will occur again at next operation.

## 7.6 Refrigerant circuit repair



Before any intervention with devices able to create sparks, heat, naked flames etc. totally empty and blow the circuit from any refrigerant.

For leak detection, the system should be charged with nitrogen using a gas bottle with a pressure reducing valve, until 15 bar pressure is reached. Any leakage is detected using a bubble leak finder. If bubbles appear discharge the nitrogen from the circuit before brazing using the proper alloys.



Never use oxygen instead of nitrogen: explosions may occur.

Site assembled refrigerant circuits must be assembled and maintained carefully, in order to prevent malfunctions.

Therefore:

- Avoid oil replenishment with products that are different from that specified and that are pre-loaded into the compressor.
- When replacing any part of the refrigerant circuit, do not leave it exposed for more than 15 minutes.
- It is important when replacing a compressor that the task be completed within the time specified above after removing the rubber sealing caps.
- When replacing the compressor following a burn out, it is advisable to wash the cooling system with appropriate products including a filter for acid.
- When under vacuum do not switch on the compressor.

## 8. DECOMMISSIONING

### 8.1 Disconnect the unit



All decommissioning operations must be performed by authorized personnel in accordance with the national legislation in force in the country where the unit is located.

- Avoid spills or leaks into the environment.
- Before disconnecting the machine for disposal please recover:
  - the refrigerant gas;
  - Glycol mixture in the hydraulic circuit;
  - the compressor lubricating oil.

Before decommissioning the machine can be stored outdoors, providing that it has the electrical box, refrigerant circuit and hydraulic circuit intact and closed.

### 8.2 Disposal, recovery and recycling

The frame and components, if unusable, should be taken apart and sorted by type, especially copper, aluminum and steel that are present in large quantities in the machine.

All materials must be recovered or disposed in accordance with national regulations.



The refrigerant circuit of the unit contains lubricant oil that binds the disposal mode of components .

### 8.3 WEEE Directive (only EU and UK)



The crossed-out bin symbol on the label indicates that the product complies with regulations on waste electrical and electronic equipment.  
The abandonment of the equipment in the environment or its illegal disposal is punishable by law.

This product is included in the application of Directive 2012/19/EU on the management of waste electrical and electronic equipment (WEEE).

The unit should not be treated with household waste as it is made of different materials that can be recycled at the appropriate facilities. Inform through the municipal authority about the location of the ecological platforms that can receive the product for disposal and its subsequent proper recycling.

The product is not potentially dangerous for human health and the environment, as it does not contain dangerous substances as per Directive 2011/65/EU (RoHS), but if abandoned in the environment it has a negative impact on the ecosystem.

Read the instructions carefully before using the unit for the first time. It is recommended not to use the product for any purpose other than that for which it was designed, as there is a risk of electric shock if used improperly.

## 9. DIAGNOSIS AND TROUBLESHOOTING

### 9.1 Fault finding

All units are checked and tested at the factory before shipment, however, during operation an anomaly or failure can occur.



BE SURE TO RESET AN ALARM ONLY AFTER YOU HAVE REMOVED THE CAUSE OF THE FAULT; REPEATED RESET MAY RESULT IN IRREVOCABLE DAMAGE TO THE UNIT AND IMMEDIATELY VOID THE WARRANTY

Code	Description	Type	Effect	Modbus
AL001	Unit - Remote alarm	User reset	Switch off unit	DI0367
AL002	Unit - Error in the number of retain memory writings	User reset	Only indication	DI0368
AL003	Unit - Error in retain memory writings	User reset	Only indication	DI0369
AL004	Unit - User inlet water temperature probe	Auto reset	Switch off user regulation (*1)	DI0406
AL005	Unit - User outlet water temperature probe	Auto reset	Switch off user regulation (*1)	DI0408
AL006	Unit - Source inlet water temperature probe	Auto reset	Only indication	DI0405
AL007	Unit - External temperature probe	Auto reset	Only indication	DI0249
AL008	Unit - User pump 1 overload	User reset	Switch off user regulation	DI0346
AL010	Unit - Flow switch alarm, no flow present with user pump 1 active	Auto reset until: 5 times in 3600s	Switch off user regulation	DI0258
AL012	Unit - User pump group alarm	User reset	Switch off user regulation	DI0400
AL014	Unit - User 1 pump maintenance	Auto reset	Only indication	DI0294
AL016	Unit - High chilled water temperature	Auto reset	Only indication	DI0276
AL017	Unit - Low plant water temperature	Auto reset	Only indication	DI0319
AL018	Unit - Low DHW water temperature	Auto reset	Only indication	DI0312
AL019	Unit - Alarm antifreeze advanced in HP mode	Auto reset	Indication and forcing on unit	DI0186
AL020	Unit -DHW temperature probe	Auto reset	Switch off DHW regulation	DI0212
AL022	Unit - Plant temperature probe alarm	Auto reset	Switch off user regulation (*1)	DI0409
AL024	Unit - DHW 1 pump maintenance	Auto reset	Only indication	DI0285
AL025	Unit - DHW pump group alarm	User reset	Switch off DHW regulation	DI0211
AL026	Unit - Flow switch alarm, no flow present with DHW pump 1 active	Auto reset until: 5 times in 3600s	Switch off DHW regulation	DI0256
AL027	Unit - DHW pump 1 overload	User reset	Switch off DHW regulation	DI0344
AL028	Unit - External coil temperature probe	Auto reset	Only indication	DI0248
AL029	Unit - Alarm user antifreeze by water temperature in chiller mode	Auto reset	Switch pump off compressor, forced on user	DI0189
AL030	Unit - Alarm user antifreeze by water temperature in heat pump mode	Auto reset	Forced on user pump	DI0190
AL033	Unit - DHW water outlet temperature probe alarm	Auto reset	Only indication	DI0210
AL034	Unit - BMS Offline alarm	Auto reset	BMS offline management, see specific chapter	DI0195
AL035	Circuit 1 - High pressure alarm by analog input - HIDROS MADE	Auto reset until: 3 times in 3600s	Switch off circuit 1	DI0277
AL036	Circuit 1 - Defrost is finished by max time - HIDROS MADE	Auto reset	Only warning	DI0207
AL037	Circuit 1 - Low pressure alarm by analog input - HIDROS MADE	Auto reset until: 3 times in 3600s	Switch off circuit 1	DI0320
AL038	Unit - Generic alarm - HIDROS MADE	Auto reset	Switch off Unit or only indication depends by conf (HiPar_GeneralAl_Behavior)	DI0265
AL039	Unit - Phase Seq alarm - HIDROS MADE	Auto reset until: 3 times in 3600s	Switch off Unit	DI0357
AL092	Circuit 1 - Defrost interrupted by a circuit alarm	Auto reset	Only indication	DI0208
AL093	Circuit 1 - Alarm discharge probe pressure	Auto reset	Switch off circuit 1	DI0235
AL094	Circuit 1 - Alarm suction probe pressure	Auto reset	Switch off circuit 1	DI0384
AL096	Circuit 1 - Alarm suction probe temperatu	Auto reset	Switch off circuit 1	DI0338
AL098	Circuit 1 Envelope - High compression ratio	Auto reset	Switch off circuit 1	DI0272
AL099	Circuit 1 Envelope - High discharge pressure	Auto reset until: 3 times in 3600s	Switch off circuit 1	DI0229
AL100	Circuit 1 Envelope - High motor current	Auto reset	Switch off circuit 1	DI0270
AL101	Circuit 1 Envelope - High suction pressure	Auto reset	Switch off circuit 1	DI0380
AL102	Circuit 1 Envelope - Low compression ratio	Auto reset	Switch off circuit 1	DI0313
AL103	Circuit 1 Envelope - Low differential pressure	Auto reset	Switch off circuit 1	DI310
AL104	Circuit 1 Envelope - Low discharge pressure	Auto reset	Switch off circuit 1	DI0233
AL105	Circuit 1 Envelope - Low suction pressure	Auto reset	Switch off circuit 1	DI0382
AL106	Circuit 1 Envelope - High discharge temperature	Auto reset	Switch off circuit 1	DI0231
AL107	Circuit 1 EVD - Low SH	Auto reset until: 3 times in 3600s	Switch off circuit 1	DI0315
AL108	Circuit 1 EVD - LOP	Auto reset	Switch off circuit 1	DI0308
AL109	Circuit 1 EVD - MOP	Auto reset	Switch off circuit 1	DI0325
AL110	Circuit 1 EVD - High condensing temperature	Auto reset	Switch off circuit 1	DI0274

Code	Description	Type	Effect	Modbus
AL110	Circuit 1 EVD - High condensing temperature	Auto reset	Switch off circuit 1	DI0274
AL111	Circuit 1 EVD - Low suction temperature	Auto reset	Switch off circuit 1	DI0317
AL112	Circuit 1 EVD - Motor error	User reset	Switch off circuit 1	DI0241
AL113	Circuit 1 EVD - Emergency closing	Auto reset	Switch off circuit 1	DI0243
AL114	Circuit 1 EVD - Setting out of bound	Auto reset	Switch off circuit 1	DI0358
AL115	Circuit 1 EVD - Settings range error	Auto reset	Only indication	DI0365
AL116	Circuit 1 EVD - Offline	Auto reset	Switch off circuit 1	DI0338
AL117	Circuit 1 EVD - Low battery	Auto reset	Only indication	DI0193
AL118	Circuit 1 EVD - EEPROM	Auto reset	Only indication	DI0245
AL119	Circuit 1 EVD - Incomplete valve closing	Auto reset	Switch off circuit 1	DI0301
AL120	Circuit 1 EVD - Firmware not compatible	Auto reset	Switch off circuit 1	DI0263
AL121	Circuit 1 EVD - Configuration error	Auto reset	Switch off circuit 1	DI0197
AL159	Circuit 1 - User alarm freeze evaporation temperature	Auto reset until: 3 times in 3600s	Switch off circuit 1	DI0260
AL160	Circuit 1 - Compressor 1 maintenance	Auto reset	Only indication	DI0280
AL161	Circuit 1 - Compressor 2 maintenance	Auto reset	Only indication	DI0282
AL162	Circuit 1 - Alarm condensing temperature probe	Auto reset	Switch off circuit 1	DI0199
AL163	Circuit 1 - Source fan 1 circuit 1 maintenance	Auto reset	Only indication	DI0287
AL166	Circuit 1 - High pressure alarm by pressure switch	Auto reset until: 3 times in 3600s	Switch off circuit 1	DI0278
AL167	Circuit 1 - Low pressure alarm by pressure switch	Auto reset until: 3 times in 3600s	Switch off circuit 1	DI0321
AL168	Circuit 1 - Overload compressor 1	User reset	Switch off compressor 1 circuit 1	DI0340
AL169	Circuit 1 - Overload compressor 2	User reset	Switch off compressor 2 circuit 1	DI0342
AL170	Circuit 1 - Pump-Down end for max time	Auto reset	Only indication	DI0360
AL375	AL_HrsPlantHeater	Auto reset	Unit - Plant heater maintenance	DI0286
AL376	AL_HrsDHWHeater	Auto reset	Unit - DHW heater maintenance	DI0284
AL380	AI_IO_Conf	Auto reset	1)Param_IO Out Of Bounds 2)Duplicate input conf 3)Duplicate output conf	DI0303

**10. DIMENSIONAL DRAWING**



Dimensional drawings are to be considered indicative and not binding, therefore it is always necessary to request the definitive dimensional drawing before setting up the installation of the unit.

PAE 881 Kp  
PAE 881 WA Kp

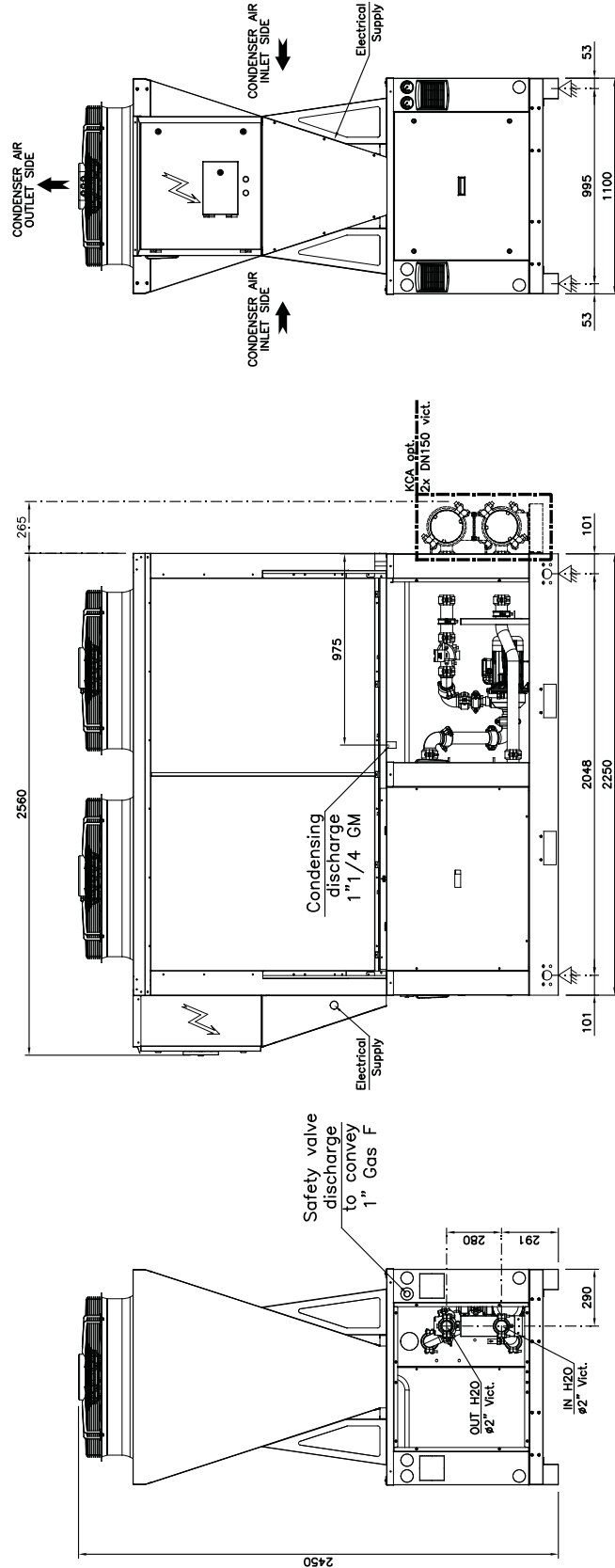

GPE 881 Kp

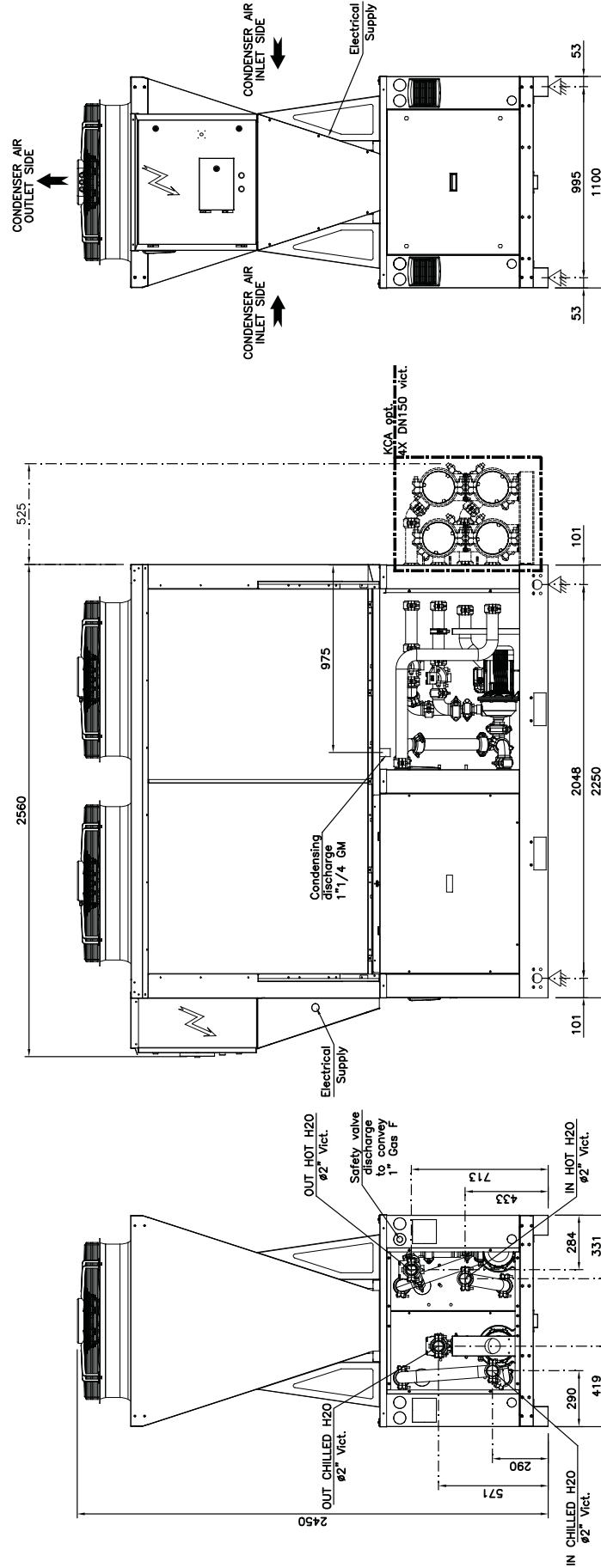

EVEREST CONNECTIVITY

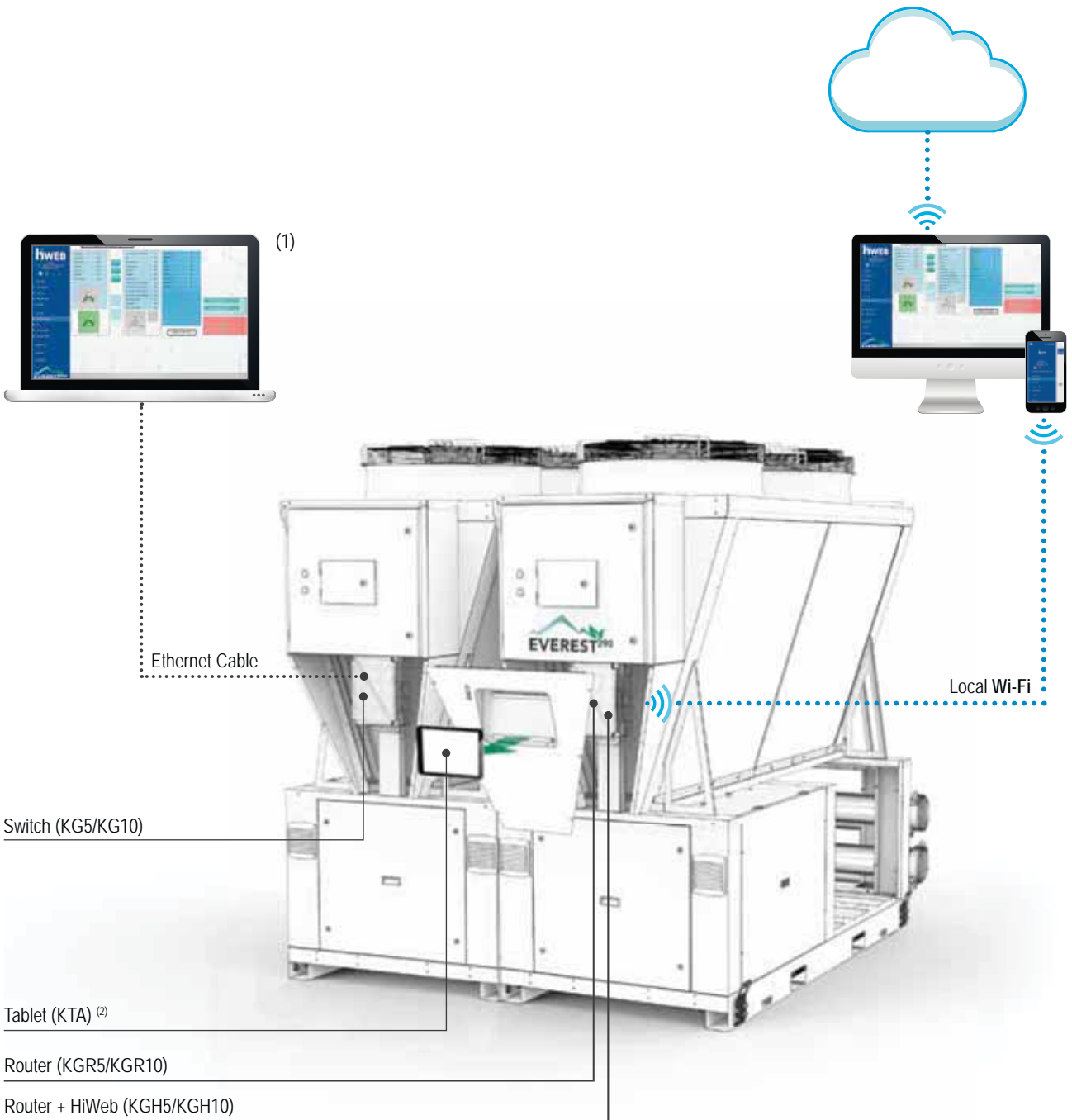

	Hardware Interfaces				Possible communications (local network)	Software Interfaces	
	PGD	Customer' smartphone/tablet/pc	Tablet kit KTA <sup>(2)</sup>	PC		c-field	HiWeb
KGH1							
KGR1							
KG5	√			√		√ <sup>(1)</sup>	
KGR5	√	√	√	√	√	√	
KGH5	√	√	√	√	√	√	√
KG10	√			√		√ <sup>(1)</sup>	
KGR10	√	√	√	√	√	√	
KGH10	√	√	√	√	√	√	√

(1) PC connected to the switch through Ethernet cable

(2) Included in the KTA kit

## ACCESSORIES

### KG5 - Gateway framework kit up to 5 units

### KG10 - Gateway framework kit up to 10 units

Frameworks for communication data with each module of a modular system. The provision for mounting the panel is on the back of the front cover of each unit. The prearrangement for the panel installation is placed on the front-cover back of each unit. Mandatory kit for systems with two or more modules. The supply does not include cables (power or data transmission) for the connection of the kit to the unit. The KNS (network starter kit) will be supplied in conjunction with the panel, a device that allows the modular system to be restarted after an electrical blackout. (The material is supplied in kits).

### KGR1 - Gateway kit for single module complete with Wi-Fi router

Framework that allows the monitoring and supervision of the main operating parameters by accessing the local Wi-Fi network. The interface that can be used can be a customer device (smartphone or tablet). The arrangement for mounting the panels is on the back of the front cover of each unit. The supply does not include cables (power or data transmission) for the connection of the kit to the unit (Supplied in kit).

### KGR5 - Gateway board kit from 2 to 5 units complete with Wi-Fi router

### KGR10 - Gateway board kit from 6 to 10 units complete with Wi-Fi router

Frameworks for communication and interfacing data with each module of a modular system. It allows the monitoring and supervision of the main operating parameters of the single modules, via local Wi-Fi network. The interface that can be used can be a customer device (smartphone or tablet) or the tablet interface integrated in the unit (kit KTA). The arrangement for mounting the panels is on the back of the front cover of each unit. The supply does not include cables (power or data transmission) for the connection of the kit to the unit (Supplied in kit).

### KGH1 - Gateway kit for single module complete with Hi-Web and Wi-Fi router

Framework that allows the monitoring and supervision of the main operating parameters by accessing the Hi-Web platform from the local Wi-Fi network. The interface that can be used can be a customer device (smartphone or tablet). The arrangement for mounting the panels is on the back of the front cover of each unit. The supply does not include cables (power or data transmission) for the connection of the kit to the unit (Supplied in kit).

### KGH5 - Gateway framework kit from 2 to 5 units provided with Hi-Web and router Wi-Fi

### KGH10 - Gateway framework kit from 6 to 10 units provided with Hi-Web and router Wi-Fi

Frameworks for communication and interfacing data with each module of a modular system. It allows the monitoring and supervision of the main operating parameters of the single modules and the whole system, by accessing the Hi-Web platform from the local Wi-Fi network. The interface that can be used can be a customer device (smartphone or tablet) or the tablet interface integrated in the unit (optional KTA). The arrangement for mounting the panels is on the back of the front cover of each unit. The supply does not include cables (power or data transmission) for the connection of the kit to the unit (Supplied in kit).

**KTA - Kit tablet interface:** Integrated inside the front cover of the unit and protected by a sheet metal door with key, it allows access to the Hi-Web and then visualization and complete control of the main operating parameters of the modular system (available in association with KGR5/10 or KGH5/10 and supplied in kit).



## 11. INTRODUCTION

The PLC control on each module contains a user interface program that can be used on devices connected to a local Wi-Fi network or via the Web (upon internet connection of the unit).

This programs allows to access all the functions present in the basic graphic display installed onboard the machine (PGD) and it allows to interact with the PLC control of each module that make up the unit in a simple and fast way.

Furthermore, the HIWEB interface is available, a system for data (SCADA) monitoring, acquiring, supervising which allows to send any scheduled reports or anomalies via e-mail in real-time too. It can also automatically send controls to the system according an established calendar.

If combined with an onboard router with SIM, it can also send text messages to preset recipients, in case of a machine alarm.

### 11.1 KG5/KG10 kit installation

The installation of the KG5/KG10 in one of the external module of the modular system is recommended.

1. Unscrew the screws **(A)** and remove the closing panel
2. Fix the panel through 2 M6x20 screws using the threaded inserts present on the pillar **(B)**

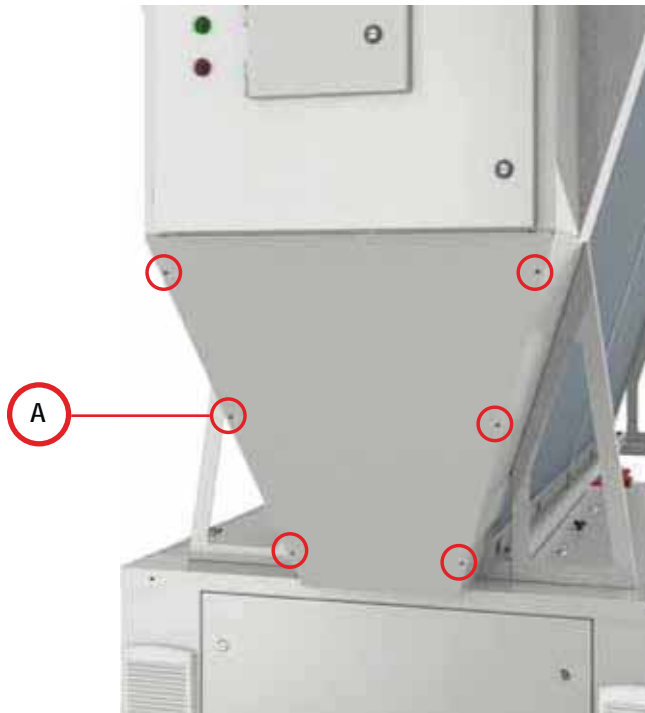

3. Bring the power supply to the sockets following the wiring diagram provided **(A)**.
4. Connect to the ethernet ports of the switches:
  - the network cables coming from all the modules that make up the modular system **(B)**;
  - the network cable of the module on which the KG5/KG10 kit is installed **(C)**;
  - the network cable coming from the router (if the KGR5/KGR10 kit or the KGH5/KGH10 kit is present) **(D)**.

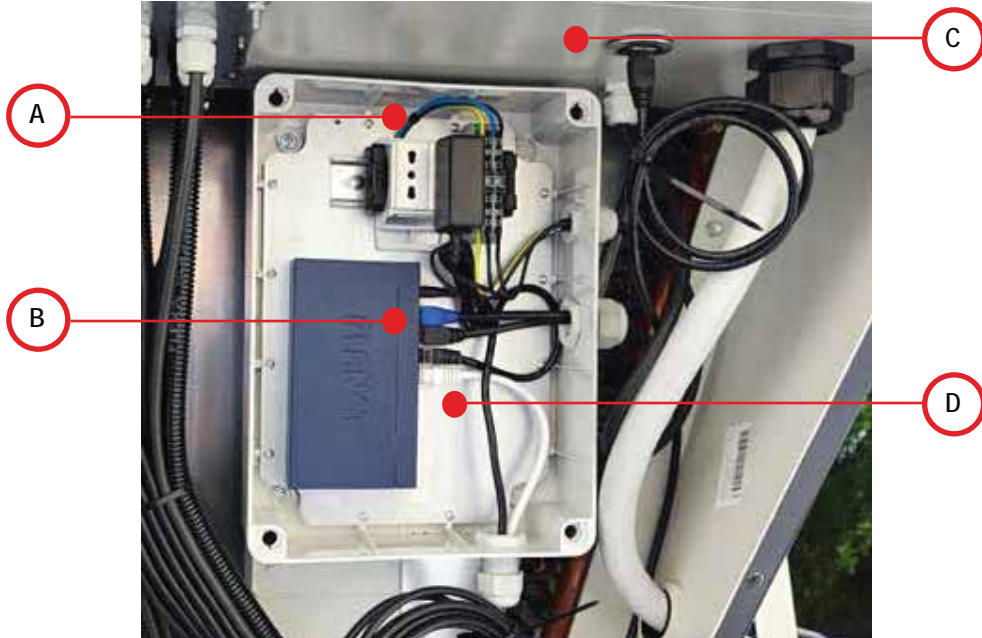

### 11.2 KGR5/KGR10 and KGH5/KGH10 kit installation

The installation of the KGR5/KGR10 and KGH5/KGH10 kit on the adjacent module with respect to the one in which the KG5/KG10 kit is installed is recommended

1. Follow the instructions at the points 1, 2 and 3 of the paragraph 2.1
2. Connect the cable from the KG5/KG10 kit to the router **(A)**

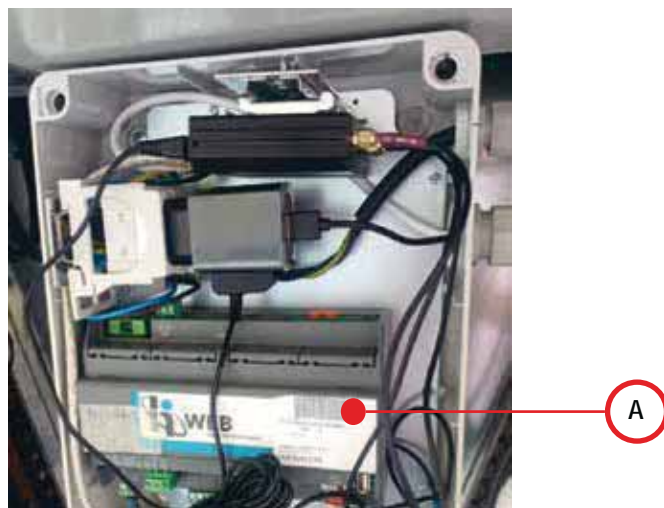

3. Fix the external antenna to the side panel by opening the specific sheet precut (A) and connect 3 cables (LTE MAIN, LTE AUX and WI-FI MAIN) of the antenna (B) to the router (C) as shown in the images.

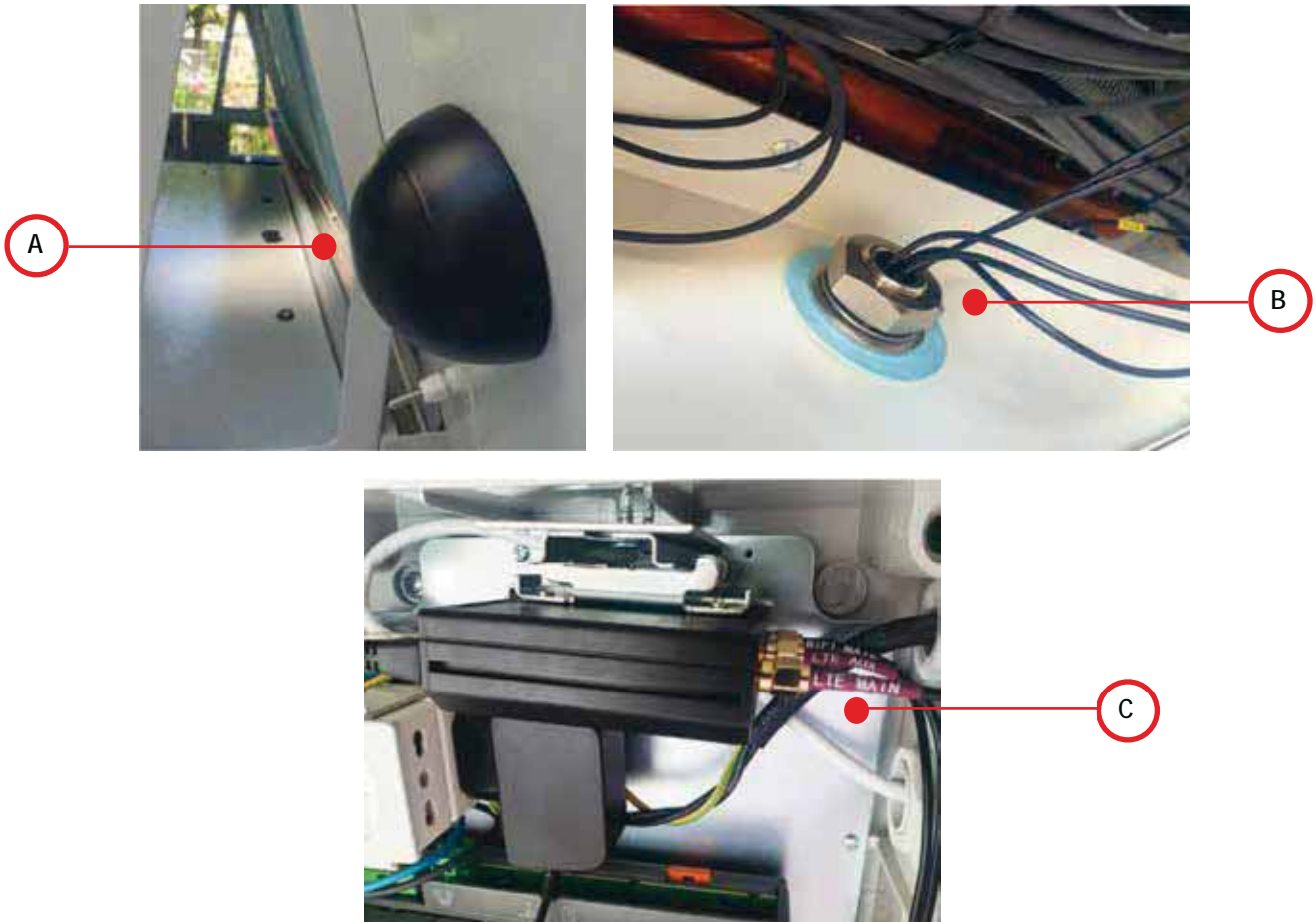

### 11.3 KTA kit installation

It is mandatory to install the KTA kit on the same module in which the KGH5/KGH10 kit or the KGR5/KGR10 kit is present

1. Follow the instructions at the point 1 of the paragraph 2.1;
2. Open the box of the KGH5/KGH10 kit or KGR5/KGR10 kit previously installed and insert the power supply of the tablet in the socket present inside;
3. Connect the usb cable to the power supply of the tablet (A) and take it out from the box passing inside the cable gland positioned in front of the socket;
4. Close the box of the KGH5/KGH10 or KGR5/KGR10 kit and, before mounting the KTA kit panel, ensure to enter the power supply cable inside the compartment containing the tablet using the specific passing hole (B);
5. Connect the power supply cable to the port of the tablet (C).



## 12. ACTIVATION AND USE

The methods for activating and using the local Wi-Fi network and activating and using an Internet connection for remote management of the modules are described below.

### 12.1 Local Wi-Fi

If the modular system is equipped with a router accessory (KGR5/KGR10 or KGH5/KGH10), it is possible to access locally, with a smartphone or tablet device with a Web browser, the local Wi-Fi network that the router automatically creates. In order to establish the connection and access the Web page of the unit controller, proceed as follows:

1. Approach the module in which the KGR5/KGR10 or KGH5/KGH10 accessory is installed, then:
  - a. Find the **hprweb** network among the Wi-Fi networks available in your device
  - b. Connect to the hprweb network using the password **!hellohvac!**
2. After connecting the device to the hprweb network, in order to access the module connect with a browser to the link <http://192.168.0.200> (this is the standard address, alternatively write the correct address).
3. Only with KGH5/KGH10 accessory: Once the device has been connected to the hprweb network, to access the system point the browser to the link <http://192.168.0.150> to interact with the SCADA.



1. LINK TO WIFI NETWORK LOGIN



2. LINK TO WEB PAGE



It is possible to use the two QR codes shown above to access the local Wi-Fi networks and the Web page of the HiWeb interface respectively.

In case of failure of the network connection, perform the following before trying again:

- Disconnect and re-connect the power supply to the unit
- Disconnect/remove the WI-FI network
- Disable mobile data traffic on your smartphone

At this point, try again by repeating the 3 steps of the procedure for connecting to the Wi-Fi network

### 12.2 Connections with the KTA kit

If the modular system has the KTA tablet accessory:

1. With the tablet, establish the connection to the hprweb network, using the same procedure described at the point 1 of the paragraph "3.1 Local Wi-Fi". This operation only needs to be performed the first time.
2. So, use a browser (default Chrome) to reach the link:
  - a. <http://192.168.0.200> to access the master module (this is the standard address, alternatively write the correct address).
  - b. <http://192.168.0.150> to access the HiWeb data supervision and acquisition control module.



From the browser, save the access link on the Home menu of the tablet in order to find it easily.

To have a better visualization of the Web pages, it is recommended to download "Fully Kiosk Browser" from the following address:  
<https://www.fully-kiosk.com/>.

APPENDIX A - PAE Kp Instructions Kit KCA

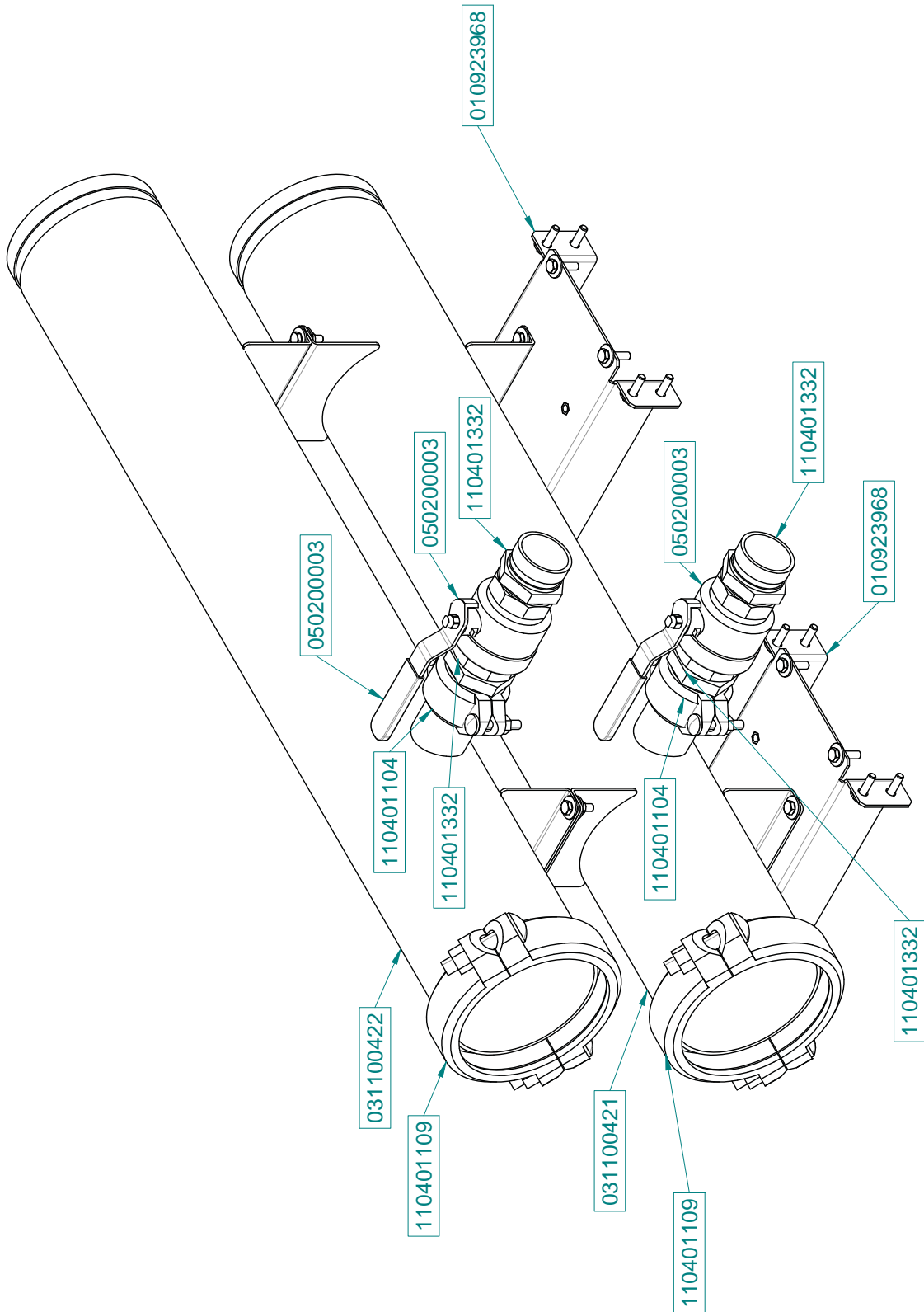



APPENDIX B - PAE Kp Instructions Kit KTT

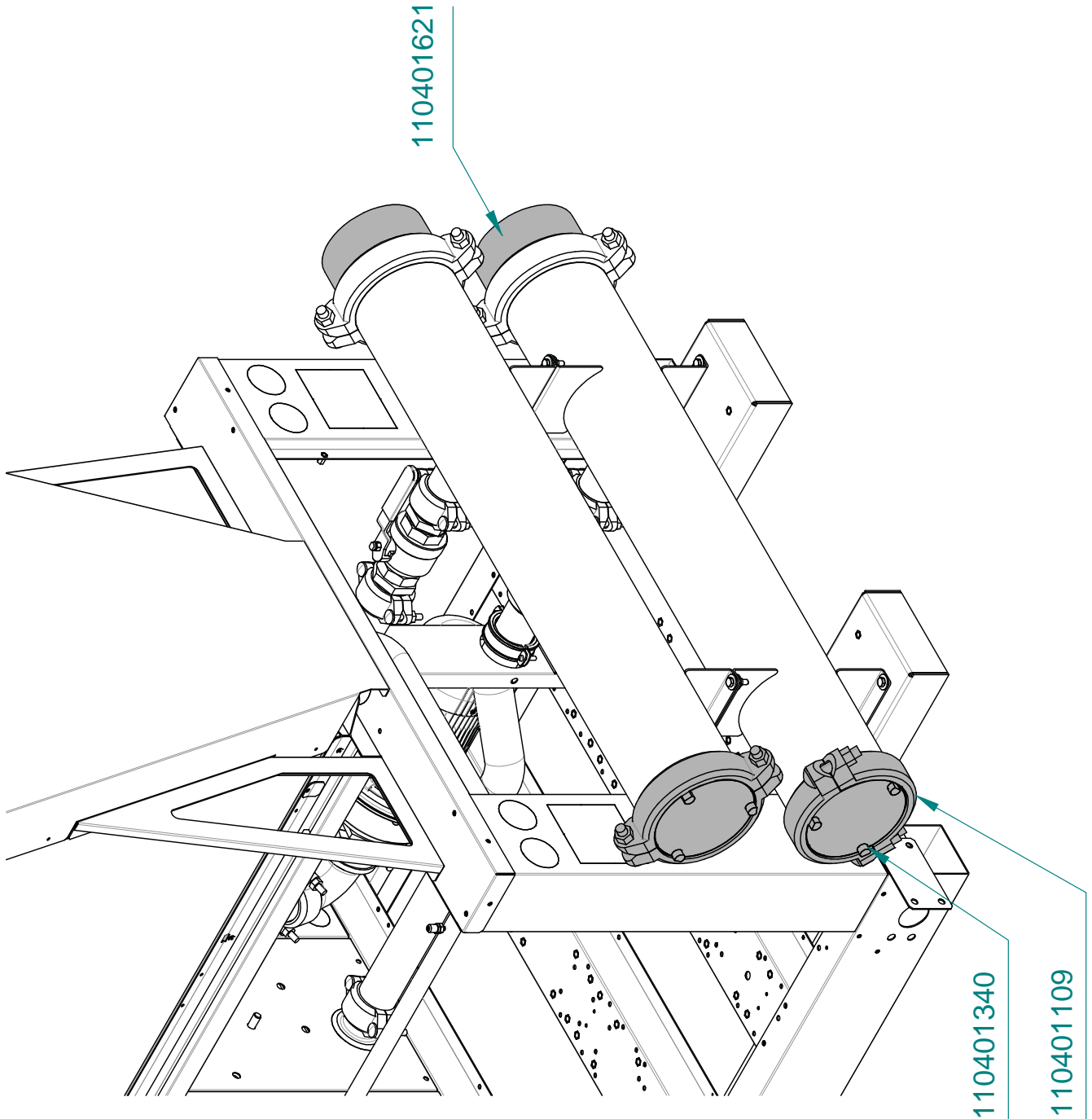

APPENDIX C - GPE Kp Instructions Kit KCA

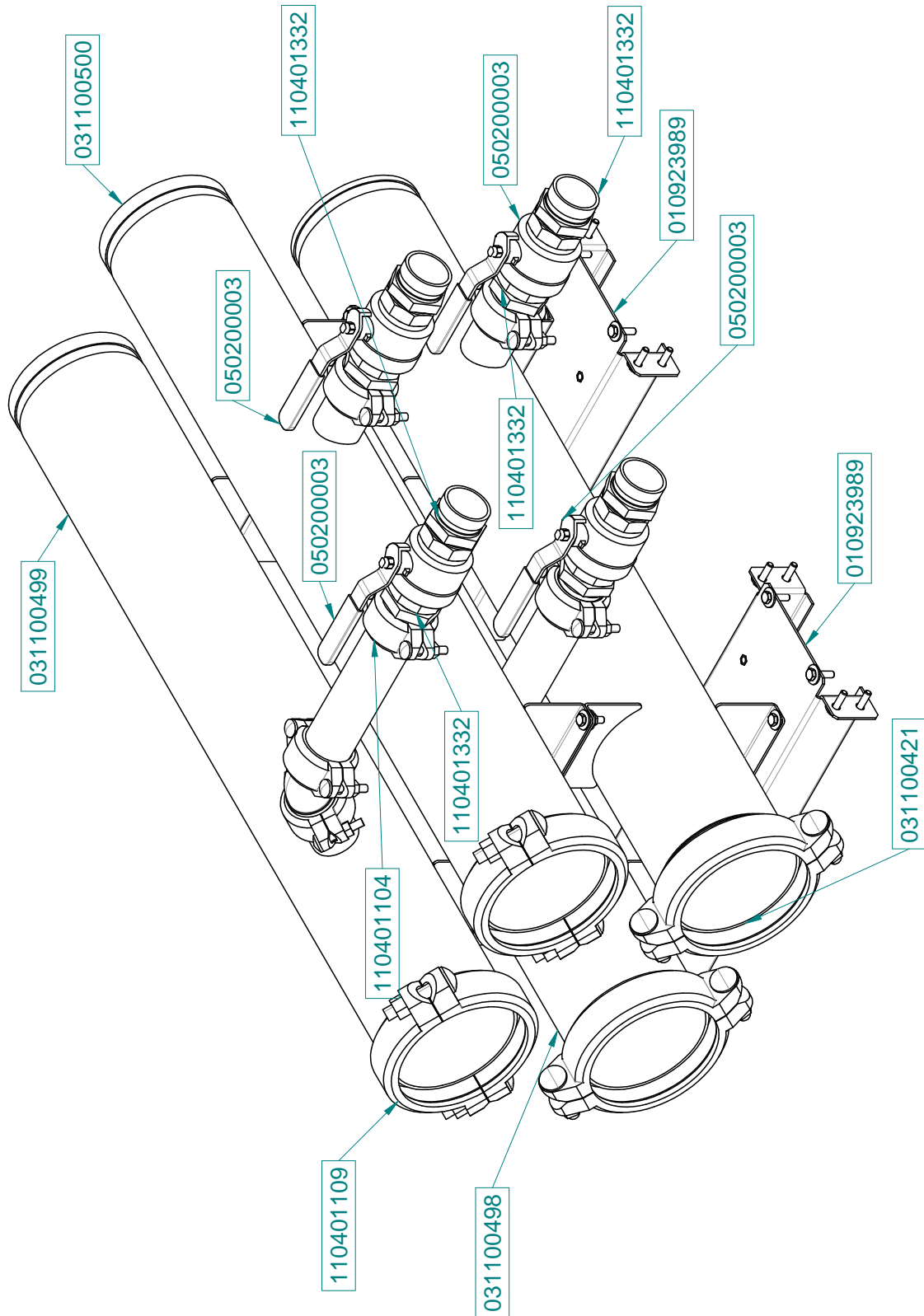

APPENDIX D - GPE Kp Instructions Kit KTT

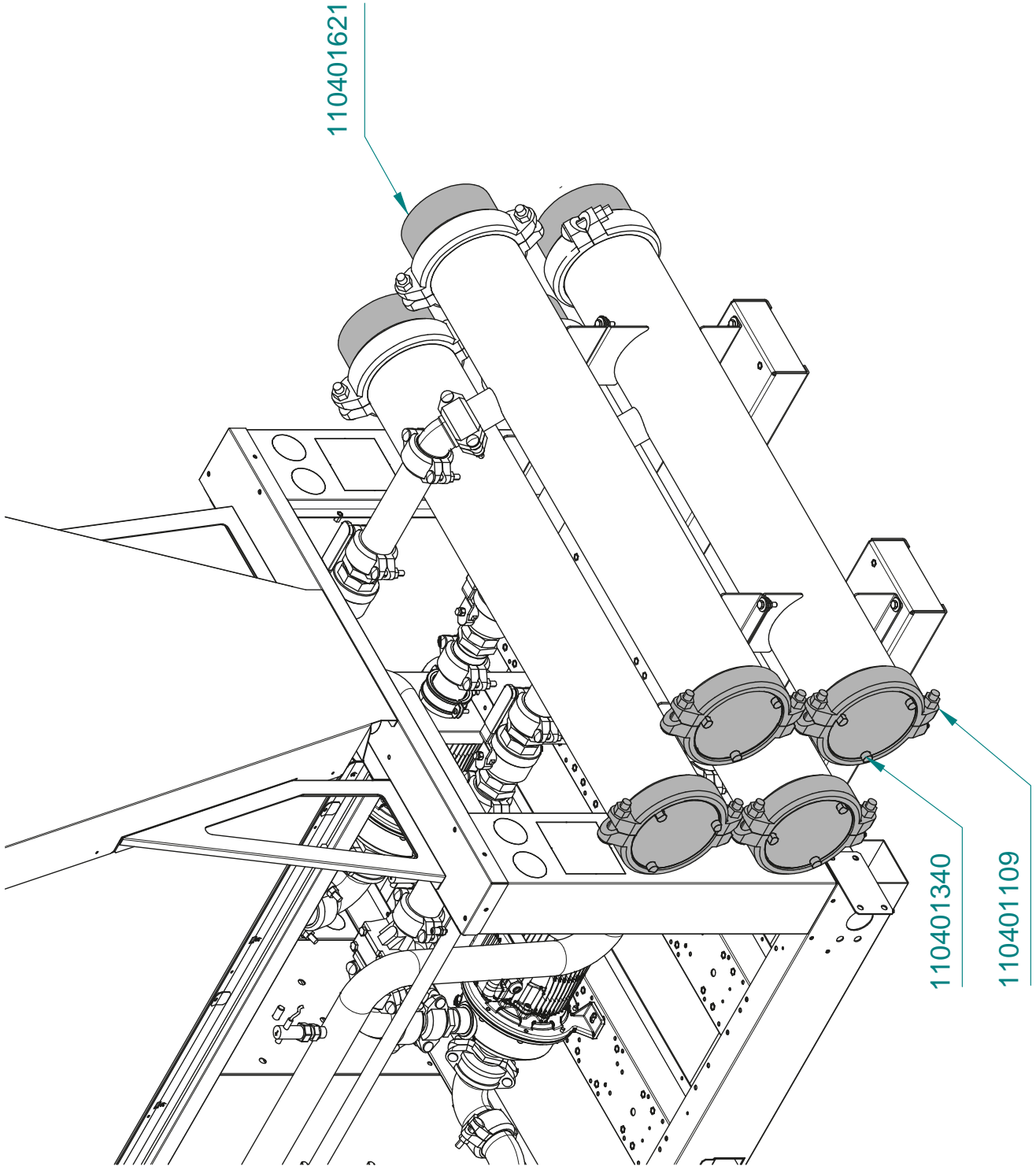











---

ESEX TECHNOLOGIES

VIA DELLE INDUSTRIE, 7 • CAP 31030 • VACIL DI BREDA DI PIAVE (TV)  
TEL. +39 0422 605 311

[Info@enextechnologies.com](mailto:Info@enextechnologies.com) • [www.enextechnologies.com](http://www.enextechnologies.com)

Technical data shown in this booklet are not binding.

The Company shall have the right to introduce at any time whatever modifications necessary to the improvement of the product.  
The reference languages for the whole documentation are Italian and English. The other languages are to be considered only as guidelines.

